

# AIR & SPACE POWER *History*

FALL 2022 - Volume 69, Number 3  
WWW.AFHISTORY.ORG

know the past  
....*Shape the Future*





Center: McConnell.  
Clockwise from Top  
Right: Doolittle and  
LeMay, Chapman,  
Leavitt, Phillips, James  
and Olds, Pitsenbarger.

# Can you name 75 Great Airmen?

Help AFHF Choose



The Air Force Historical Foundation is preparing a book featuring **75 Great Airmen** who served between 1947 and today. Look for the book in 2022 to celebrate the Air Force's 75<sup>th</sup> Anniversary. Send your nominations to [75Great@afhistory.org](mailto:75Great@afhistory.org)

# AIR & SPACE POWER *History*

Fall 2022 - Volume 69, Number 3  
WWW.AFHISTORY.ORG

know the past  
.....*Shape the Future*

Features	Oscar Deuce and the Duckbutts: The USAF O-2 Skymaster Self-Deployment to South Vietnam <i>Jayson A. Altieri</i>	<b>5</b>
	The Man in Black, Coach Pop and Intelligence in the U.S. Air Force <i>Scott C. Martin</i>	<b>13</b>
	Command, Control, and Communications of Bomber Forces in World War II and the Korean War <i>James D. Perry</i>	<b>19</b>
	The Cambodian Incursion <i>Garry N. Willis</i>	<b>27</b>
	Pioneering Air Evacuation in World War II <i>Grant T. Harward</i>	<b>35</b>
Book Reviews	<i>Pacific Profiles, Volume Six, Allied Fighters: Bell P-39 &amp; P-400 Airacobra, South &amp; SW Pacific 1942-44</i> By Michael Claringbould	Review by Frank Willingham <b>50</b>
	<i>South Pacific Air War Volume 5: Crisis in Papua, September-December 1942</i> By Michael Claringbould & Peter Ingman	Review by Frank Willingham <b>50</b>
	<i>The Mosquito in the USAAF</i> By Tony Fairbairn	Review by Jon Barrett <b>51</b>
	<i>B-25 Mitchell vs. Japanese Destroyer: Battle of the Bismark Sea 1943</i> By Mark Lardas	Review by Steven D. Ellis <b>51</b>
	<i>Fighter 'Gator</i> By John E. Norvell	Review by Donald M. Bishop <b>52</b>
	<i>A History of the Mediterranean Air War 1940-1945 Vol. Five: From the Fall of Rome to the End of the War</i> By Christopher Shores & Giovanni Masimello, et al	Review by Steven D. Ellis <b>53</b>
	<i>We Were Never There Volume 2: CIA U-2 Asia and Worldwide Operations 1957-1974</i> By Kevin Wright	Review by Charles P. Wilson <b>53</b>
	<i>America's Few: Marine Aces of the South Pacific</i> By Bill Yenne	Review by Steven Agoratus <b>54</b>
	<i>Seven Seconds to Die: A Military Analysis of the Second Nagorno-Karabakh War &amp; the Future of ...</i> By John Antal	Review by John Cirafici <b>54</b>
	<i>CIA Station D: Area 51: The Complete Illustrated History of the CIA's Station D at Area 51</i> By Thornton D. Barnes	Review by Charles P. Wilson <b>55</b>
	<i>Going Downtown: The US Air Force Over Vietnam, Laos and Cambodia, 1961-75</i> By Thomas McKelvey Cleaver	Review by Frank Willingham <b>55</b>
	<i>"Big Week" 1944: Operation Argument and the Breaking of the Jagdwaffe</i> By Douglas Dildy	Review by Steven Agoratus <b>56</b>
	<i>Escape from Java: The Extraordinary World War II Story of the U.S.S. Marblehead</i> By John J. Domagalski	Review by Steven D. Ellis <b>57</b>
	<i>Red Star Versus Rising Sun Volume 2: The Nomonhan Incident 1939</i> By Adrien Fontanellaz	Review by Gary Connor <b>57</b>
	<i>Operation Vengeance: The Astonishing Aerial Ambush the Changed World War II</i> By Dan Hampton	Review by Gary Connor <b>58</b>
	<i>The Role of Intelligence in the Battle of Britain</i> By Norman Ridley	Review by Edward Young <b>59</b>
	<i>The Men Who Gave Us Wings: Britain &amp; the Aeroplane 1796-1914</i> By Peter Reese	Review by Joseph Romito <b>59</b>
	<i>Finnish Aces: Their Planes and Units 1939-1945</i> By Kari Stenman & Karolina Holda	Review by Scott A. Willey <b>60</b>
	<i>The Oil Campaign 1944-1945: Draining the Wehrmacht's Lifeblood</i> By Steven Zaloga	Review by Steven D. Ellis <b>60</b>
	Additional Book Reviews are in Supplement after the back cover	
Departments	President's Message	<b>3</b>
	Upcoming Events	<b>62</b>
	History Mystery	<b>64</b>

COVER: A BLU-82 "Daisy Cutter" such as this one was used in Commando Vault to clear the way for landings during the 1970 Cambodian incursion.





**Air Force Historical Foundation**

P.O. Box 790  
Clinton, MD 20735-0790  
(301) 736-1959

**E-mail: [angelabear@afhistory.org](mailto:angelabear@afhistory.org)  
On the Web at <http://www.afhistory.org>**

**Board of Directors**

Gen James M. "Mike" Holmes, USAF (Ret.)  
Chairman  
Ms. Jonna Doolittle Hoppes, President  
Lt Gen John L. Barry, USAF (Ret.)  
First Vice Chairman  
Dr. Rebecca Grant, Secretary  
Col Stephen E. Newbold, USAF (Ret.)  
Treasurer  
Col Eileen Bjorkman, USAF (Ret.)  
Col Christopher J. Brunner, USAF (Ret.)  
Lt Joseph Burke, USAFR (Ret.)  
Dr. Richard P. Hallion  
Lt Gen Charles R. Heflebower, USAF (Ret.)  
Brig Gen Patrick C. Malackowski, USAF (Ret.)  
Dr Richard I. Wolf

**Emeritus**

Maj Gen Dale W. Meyerrose, USAF (Ret.)  
Chairman

**Editor, *Air & Space Power History***

Richard I. Wolf

**Editor Emeritus, *Air Power History***

Jacob Neufeld

**Staff**

Lt Col Dik A. Daso, USAF (Ret.)  
Interim Executive Director  
Mrs. Angela J. Bear, Office Manager

**President's Circle**

Lt Col Kenneth W. Sublett, USAF (Ret.)

**Benefactor**

Col Terry Balven, USAF (Ret.)  
Gen James P. McCarthy, USAF (Ret.)

**Patron Members**

Dr. John Farquhar  
Lt Col Raymond Fredette, USAF (Ret.)  
Dr. Jerome V. Martin  
Brig Gen William L. Shields, USAF (Ret.)  
Brig Gen Wade R. Smith

**Donations**

Gen Michael Carns, USAF (Ret.)  
Maj Gen Charles J. Dunlap, Jr., USAF (Ret.)  
Lt Gen Nicholas B. Kehoe, USAF (Ret.)  
John F. Kreis  
Dr. John Farquhar  
Lt Gen Charles R. Heflebower, USAF (Ret.)  
John Kennedy  
Richard Lawless  
Gen James P. McCarthy, USAF (Ret.)  
Brig Gen Robert R. Scott, USAF (Ret.)  
Brig Gen William L. Shields, USAF (Ret.)  
Lt Col Kenneth W. Sublett, USAF (Ret.)  
Steve Simon  
L. Parker Temple  
Edward Young

**Corporate Sponsors**

Boeing  
Calvert Systems  
General Atomics  
General Electric Aviation  
Leidos  
Lockheed Martin  
L3Harris Technologies  
Northrop Grumman  
Pratt & Whitney  
Wings over the Rockies Air Museum

**AIR & SPACE  
POWER *History***

The Journal of the  
**Air Force Historical Foundation**  
Fall 2022 Volume 69 Number 3

**Editor**  
Richard I. Wolf

**Editor Emeritus**  
Jacob Neufeld

**Book Review Editor**  
Scott A. Willey

**Advertising**  
Dik A. Daso

**Circulation**  
Angela J. Bear

*Air & Space Power History* (ISSN 1044-016X) is produced for Spring, Summer, Fall, and Winter by the Air Force Historical Foundation.

Prospective contributors should consult the **GUIDELINES FOR CONTRIBUTORS** at the back of this journal. Unsolicited manuscripts will be returned only on specific request. The Editor cannot accept responsibility for any damage to or loss of the manuscript. The Editor reserves the right to edit manuscripts and letters.

Address **LETTERS** and **manuscripts** to:

Air & Space Power History  
70 Shannon Way  
Upton, MA 01568  
e-mail: [airpowerhistory@yahoo.com](mailto:airpowerhistory@yahoo.com)

Correspondence regarding missed issues or changes of address should be addressed to the **CIRCULATION OFFICE**:

Air & Space Power History  
P.O. Box 790  
Clinton, MD 20735-0790  
(301) 736-1959  
e-mail: [angelabear@afhistory.org](mailto:angelabear@afhistory.org)

**ADVERTISING**

Executive Director  
P.O. Box 790  
Clinton, MD 20735-0790  
(301) 736-1959  
e-mail: [ed@afhistory.org](mailto:ed@afhistory.org)

Copyright © 2022 by the Air Force Historical Foundation. All rights reserved.  
Periodicals postage paid at Clinton, MD 20735 and additional mailing offices.

**Postmaster:** Please send change of address to the Circulation Office.

## Jim Vertenten's Retirement



Over time, many organizations struggle, especially organizations that have been around for nearly 70 years. They struggle financially. They struggle to remain relevant. This is true for the Air Force Historical Foundation. In 2009, our Foundation was struggling. Founded in 1953, by the early giants of the fledgling Air Force and funded, often times, by their generosity, we were running out of money and not reaching our intended audience.

In March 2010, then Chairman and President, Major General Dale Meyerrose, USAF, (Ret.), hired Jim Vertenten as Executive Director, and things began to change. Jim rolled up his sleeves on day one and never stopped working to save the Foundation.

Recognizing that today's young people operate in a digital world, Jim modernized our website, maintaining and updating it himself. Wading into social media, he reached out to our membership with *On This Day in Air Force History*, a daily post on our website and an email, Facebook, LinkedIn, Instagram, and Twitter blast high-

lighting historical Air Force events. Those posts caught on and our membership grew, pulling in a younger audience.

Digitizing AFHF's publications with JSTOR was Jim's idea. Not only was it fiscally sound, it ensured that the body of work, contained in our journals, including *Air Power Historian*, *Aerospace Historian*, *Air Power History*, and *Air and Space Power History*, dating back to 1954, is available and searchable in an electronic format. These archives are the foundation upon which our new programs are being built.

In the early days, Jim turned his focus to our awards. He rebuilt our program, elevating it to a status that is worthy of our recipients. His fingerprints are on every inch of the process from organizing the event to all those pesky details like guiding the Board's selection of candidates, liaising with Air Staff and AFSA, making sure the invitations were printed correctly, the room rented, the menus perfect, the seating charts proper, the videos working and the recipients available. That's an abbreviated list. Not only did he revamp the program, for the first time in years, we made a profit.

In 2011, he created the James H. "Jimmy" Doolittle Award, an award that recognized the contributions of an Air Force or Space Force unit in multiple conflicts. We believe this award resonates with Doolittle's deeply held belief that most of life's great achievements are achieved by a team working together toward a common goal.

Jim's consistent and effective stewardship of the Foundation's day-to-day and strategic financial affairs kept us going. When he came onboard, we were in tough financial times. He worked with our auditors, investment firm, and Board of Directors to keep the Foundation afloat. He recommended and recruited Board Members who had connections and skills. He supported every Board election and countless Board and Executive Committee meetings. He kept the Board informed and helped to make expenditure and stewardship decisions that would keep the AFHF financially viable. There were times when he worked without pay so that the Foundation could meet its financial obligations, often volunteering evenings after working all day at a day job. But in 2012, reality hit and the Board reluctantly considered steps to close the doors.

Our rescue came in the form of a large endowment from a lifetime member of the Air Force Historical Foundation. Although the donor and family requested to remain anonymous, it is acknowledged, that Jim's ability to build relationships for the Foundation is what saved us. With that lifeline, Jim worked to build the AFHF into the thriving entity that it is today.

He didn't do it alone. We had steady leadership in Maj Gen Meyerrose and Lt Gen Miller. We had and still have hard working Board Members with great ideas. We have volunteers who donate their time and expertise. We have members who generously open their checkbooks, making it possible for us to succeed. But Jim assembled these Boards and built relationships with these donors. He was the glue that held us together and the engine that kept us moving forward. I think Maj. Gen. Meyerrose said it best, "When an organization's resilience is tested, the burden falls on the shoulders of a small number of leaders in order to keep it vibrant. For the Air Force Historical Foundation over the past dozen years or so, this challenge fell to one man – Jim Vertenten. For that, we all owe him a great deal of gratitude."

You can tell a lot about a person by how they are remembered. Major General Si Johnson, USAF (Ret.), who introduced Jim to the Air Force Historical Foundation, said, "Jim Vertenten has been my friend since 1974. He was a superb Air Force officer and had a superb career in the finance world. His work as Executive Director of the AFHF has been second to none. He was the right person at the right time! Jim Vertenten is a great American and the epitome of an Airman for life!"



On July 31, 2022, Jim retired. Not only did we lose his steady leadership, we lost Dora, his wife, who has given us countless hours over the years. She, too, will be sorely missed.

Lt Gen Christopher Miller, USAF (Ret.), Chairman and President of the AFHF from 2017 until 2021, summed it up for all of us. “Jim’s retirement from the AFHF is the end of an era. He was the practical face of the Foundation to many people for the years he served as Executive Director, and will be sorely missed. He is a fountain of institutional memory, of personal connection, and a tireless advocate for Airmen, the Air Force, and air and space history.”

We are currently searching for someone to fill the position of executive director, but those are big shoes to fill. In the meantime, we are saving a seat on the Board of Directors for Jim. We’ll give him a little time to catch his breath but we’re ready when he is.

Respectfully,

Jonna Doolittle Hoppes,  
President

General James M. Holmes, USAF (Ret.)  
Chairman of the Board

## From the Editor

I wish to echo the sentiments of our leadership in wishing Jim Vertenten a fond au revoir as he retires from being our Executive Director. In my thirty years at the magazine, I can’t remember a finer human being who sat in that seat. We will all miss Jim. I know I will.

We start with an article by return contributor Jayson Altieri, who writes about how the O-2 Skymasters travelled to Vietnam. Some good history on the O-2.

Our second article is by first-time contributor Scott Martin, whose story is about the connections between Johnny Cash and Gregg Popovich, both former USAF members.

Our third article is by another first-timer James Perry, who is writing about C3 of bomber forces in World War II and Korea.

Our fourth article is by another first-time contributor, Gary Willis, a USAFA graduate who flew O-1 Bird Dogs as a FAC in Vietnam. He writes about the Cambodian Incursion.

Our final article is by yet another first-time contributor, Grant Harward, who writes about aeromedical evacuation’s development during World War II.

The Leadership’s Message begins on page 3. It’s worthy of the reading. Don’t miss Upcoming Events on page 62, although I fear you must continue to take many dates in that section as still uncertain at this point, but more firm than during the last two years. And the issue closes with the Mystery. Enjoy! We include another Book Review Supplement after the regular issue. Don’t skip it.

*Air & Space Power History* and the Air Force Historical Foundation disclaim responsibility for statements, either of fact or of opinion, made by contributors. The submission of an article, book review, or other communication with the intention that it be published in this journal shall be construed as prima facie evidence that the contributor willingly transfers the copyright to *Air & Space Power History* and the Air Force Historical Foundation, which will, however, freely grant authors the right to reprint their own works, if published in the authors’ own works.



# Oscar Deuce and the Duckbutts: The USAF O-2 Skymaster Self- Deployment to South Vietnam



USAF personnel refueling a World Aviation Services O-2 at Hickam AFB, Hawaii, circa 1967.

Jayson A. Altieri

The Vietnam War, like previous 20th century wars, brought a number of militarized civilian aircraft to the front lines that were not designed for combat use. Among these civilian aircraft used throughout the past century were the over 12,000 Cessna aircraft that served in the United States military and armed forces around the world like Cessna's O-2 Skymaster airplane.<sup>1</sup> Much of the story of Vietnam era aircraft, like the B-52 Stratofortress, F-4 Phantom and UH-1 Iroquois, are 46-years later still shrouded by legend, mystery and embellishments that do little to honor and recognize the courage and sacrifice military and civilian pilots made during the conflict. One such story involves how a group of civilian contract pilots flew a fleet of new O-2 aircraft from the Cessna factory in Wichita, Kansas across the Pacific Ocean directly to the battlefields of South Vietnam. The true story of the Cessna O-2's deployment is a lesson of planning, innovation and audacity that even in hindsight proves the flexibility of U.S. air power in meeting operational needs to support U.S. national security objectives. The story of the O-2's deployment also may serve as a lesson for future air power historians as it relates to the recent conflicts in Afghanistan and Iraq, about capturing the true stories of the men and women who serve.

## Oscar Deuce

Founded by Clyde Cessna, the Cessna Aircraft Company has produced both civilian and military aircraft since the company's inception in 1927. In the years prior to World War II Cessna would produce a number of light commercial aircraft including some models that flew on the air racing circuit. During World War Two the company shifted from building civilian use aircraft to building military models like the Cessna AT-8 Crane, or more famously, the "Bamboo Bomber," as well as a number of CG-4A gliders under contract with the Waco Aircraft Company.<sup>2</sup> As the war drew to a close, Cessna returned to peacetime production with an eye on competing with the surplus market of the post-war American airplane market.<sup>3</sup> As a result, Cessna began designing and building low-cost airplanes with the idea of a "family car of the air." This concept was based on the popular post-war notion that every American would take to the air and every family would own an airplane or helicopter.<sup>4</sup> Because of this marketing strategy several early 1950's Cessna single-engine models like the 120, 170 and 190 would become the precursors of the later and still popular Cessna designs such as the 150, 172 and 182 model aircraft still popular today.<sup>5</sup> So popular in fact were some of Cessna's designs that in 1950, the Cessna 170 model was adopted by the US Army as a light observation aircraft designated the L-19 "Bird Dog" to serve in the Korean Conflict.



Cessna O-2 Assembly Line Wichita, Kansas, date unknown. (Photo courtesy of the Kansas Historical Society.)

On February 28, 1961, the Cessna Aircraft Company introduced the revolutionary tandem twin-engine Skymaster airplane using much that was learned from their successful single-engine designs of the 1950s. This aircraft, known as the Model 336, featured centerline thrust (engines on each end of the fuselage) and twin cantilever tail booms supporting a communal stabilizer, which was the culmination of years of research and designed to develop a

*Colonel Jayson A. Altieri, USA, (Ret.), began his military service in 1984 as an enlisted Soldier with the 101st Airborne (Air Assault) Division. Commissioned in 1989 as a U.S. Army 2d Lieutenant, he served in various Army Aviation assignments with the 82nd Airborne Division, as well as units in Afghanistan, Belgium, Ecuador, Iraq, Korea, and the Panama Canal Zone. He also served in several national security level assignments with the National Geospatial Intelligence Agency, Washington, D.C.; the North Atlantic Treaty Organization, Brussels, Belgium, and the National War College, Washington, D.C. His last operational assignment was as the Commander, 110th Aviation Brigade, Fort Rucker, Alabama and is currently an Assistant Professor of Leadership at the Air War College, Maxwell Air Force Base, Alabama. He is a former Master Army Aviator and instructor pilot with more than 3000 flight hours in OH-58, TH-67, UH-1, and UH-60 helicopters. Jayson received the 2020 Air & Space Power History Article Award and has written several books and articles on aerospace and military related matters. His current book project, entitled A Guest of Mr. Lincoln: The Wartime Service of Sergeant Joseph H. Wheelless, Confederate States Army, is expected to be published sometime in early 2023.*

low-cost, safe and comfortable business aircraft.<sup>6</sup> The tandem configuration of this novel aircraft gave the Skymaster a ceiling of 27,000 feet. Tailored for the business pilot, this model was priced at \$39,950 and simplified the transition from single-engine to twin-engine aircraft.<sup>7</sup> The Skymaster went into full production and was reengineered to include retractable landing gear and provide better flying characteristics, and had updated appearance and greater speed. The Model 337 Super Skymaster, introduced in April, 1967, offered even greater performance including the 337B model with two Continental turbocharged, fuel-injected 210 horsepower engines which boosted the service ceiling to 33,000 feet, cruise speed to 233 mph and range to 1,640 miles.<sup>8</sup>

As a result of the need for durable light aircraft to fight the counter-insurgency war growing in Southeast Asia, the Super Skymaster (US military designation O-2) would find its way in the U.S. Air Force (USAF) which required a fast, tough forward air control aircraft that could support U.S. Army (USA), U.S. Marines and South Vietnamese ground forces in Vietnam.<sup>9</sup> The military O-2A model versions were armed with 2.75-inch rockets, 7.62 millimeter miniguns and large observation windows. Additionally, the O-2B models would carry 1,800-watt hi-fi loudspeakers and drop leaflets for psychological operations.<sup>10</sup> Both models were known among pilots as “Oscar Deuce” and the first order of seven aircraft were delivered to South Vietnam on May 20, 1967.<sup>11</sup>

The use of the O-2A and B models immediately proved their value in combat as attested to in a November 1967 edition of a *Cessquire* magazine article which stated:<sup>12</sup>

*The Viet Cong have come to fear the small Cessna O-1E Bird Dog flown by FAC controllers in South Vietnam. When they see it [the Bird Dog] circling near them they try to hide, for in minutes after the FAC spots them they most likely will be pounded... Now the VC are having to become familiar with a new airplane that the FACs... are receiving—the twin-boom, tandem-engine O-2A Super Skymaster.*

Clearly the new O-2s would be in high demand supporting ground forces in Vietnam as the USAF’s FACs, assigned to the Southeast Asia based Tactical Air Support Squadrons, were proving very effective in providing visual reconnaissance and artillery and/or close air support spotter information to the ground forces.<sup>13</sup> While still effective, the O-1 Bird Dog’s design shortfalls were becoming all too obvious at this point of the war in South Vietnam.

The O-1 was a simple plane: easily maintained, highly maneuverable and had good visibility with the fore and aft pilot and observer seats offering excellent views on both sides of the fuselage. As early as 1963 the Vietnam People’s Army and VC anti-aircraft defenses were increasingly sophisticated and dangerous, and slow, unarmored aircraft like the O-1 were extremely vulnerable to enemy ground fire.<sup>14</sup> In addition, the O-1’s operational times were limited by its basic instrumentation and navigational equipment, which made flying in bad weather or at night difficult. The O-1’s overall lack of weaponry was also frustrating, as



some FACs would watch the enemy disappear in the bush or a village while strike aircraft were still enroute, resulting in many O-1 pilots and/or observers resorting to attacking the enemy with small arms fired out of the plane's windows.<sup>15</sup> As a result, by March 31, 1967, the USAF began equipping the 9th Air Commando Squadron (later redesignated the 9th Special Operations Squadron) with unarmed O-2B models and the 19th, 20th 21st, 22nd, and 23rd Tactical Air Support Squadrons with Cessna O-2As one month later.<sup>16</sup> The O-2 was a temporary solution, meant to serve until the OV-10 Bronco came on line.<sup>17</sup> The aircraft carried ordnance, was capable of longer station times, had more power and featured improved conventional navigation aids and in-flight instrumentation. The challenge for USAF logisticians as the Vietnam War began to expand was how to get more of the new aircraft into theater with minimum delay and maintenance down time.

### O-2 Project

By 1967 the USAF had made its first purchase of what would become a total order of 532 O-2 series aircraft.<sup>18</sup> The main obstacle was how to deploy the initial production of 191 O-2 aircraft to theater in a timely manner. The USAF had three options: 1) Fly the aircraft from the Cessna factory to the west coast and turn them over to the USA for transport by cargo ship. 2) Remove the O-2 wings and deploy them three at a time into the cargo bay of a C-124 Globemaster II or C-133 Cargomaster transport aircraft. 3) Ferry the new Cessna aircraft under their own power to South Vietnam.<sup>19</sup> The first deployment option, delivering the aircraft by ship, while a viable and cost-effective method as demonstrated by the movement of USA transport helicopters to Vietnam on converted U.S. Navy (USN) World War II escort aircraft carriers, was in fact the slowest of the options as seen in the 1965 four-week sea movement of the USA's 228th Assault Support Helicopter Battalion aboard the USN's Boxer.<sup>20</sup> Additionally, once arriving at the ship's destination, another twelve days were usually needed to reassemble, check and test fly a cohort of seaborne aircraft before they were released for operational use.<sup>21</sup> The second option, moving aircraft via the USAF's C-124 or C-133 transports, while potentially faster at deploying aircraft across the Pacific, also required an extensive disassembly and reassembly of aircraft before and after movement and tied up much needed airlift support.<sup>22</sup> The third option, and the one chosen by the USAF, of air ferrying the Cessnas to South Vietnam, was not a new concept and had been done over the years with military aircraft including single engine aircraft, but rarely had been tried with commercial light aircraft like the O-2.

As the majority of USAF FAC pilots with experience in light observation aircraft were deployed to support operations South Vietnam, the U.S. Air Force Systems Command (AFSC) leadership elected to use civilian contract pilots to facilitate the movement of the O-2 aircraft from the Cessna plant in Wichita, Kansas to South Vietnam in what was to become known as the "O-2 Project."<sup>23</sup> The AFSC initially contracted with World Aviation Services



Col William K. Bush, 4440th Aircraft Delivery Group commander (USAF photo.)

(WAS) in Fort Lauderdale, Florida to fulfill the delivery without military oversight. WAS program managers required contract pilots have a minimum of 3000 hours flight time, 1000 hours multi-engine time, three transoceanic crossings and pass a background security check; some of the pilots WAS hired did not meet these minimum requirements so their previous experience in Cessna Skymasters was taken into account.<sup>24</sup> The WAS pilots hired were issued an airline ticket and reported to McConnell AFB in Wichita, Kansas where they were required to pass a written O-2 systems exam and complete a check-out in an O-2 aircraft. However, as a result of WAS's initial lack of proper management and oversight of the aircrew's long-range navigational training, the first and second batch of three O-2s each enroute to South Vietnam inadvertently flew off course between California and Hawaii and narrowly escaped ditching only after U.S. Coast Guard rescue aircraft were deployed to assist the wayward flights to Hickman AFB.<sup>25</sup> As a result of these incidents, Brigadier General Frank K. Everest, Jr., USAF Chief of Safety recommended, and the USAF Tactical Air Command leadership directed, that the 4440th Aircraft Delivery Group (ADG) assume full operational control of the delivery process.<sup>26</sup>

To accomplish the aforementioned task, TAC ordered Colonel William K. Bush, the USAF's 4440th ADG commander, to lead the deployment of the Cessna aircraft to Southeast Asia on May 25, 1967.<sup>27</sup> The 4440th ADG's primary mission was to plan, survey and exercise operational command of all aircraft movements and to control the funds allocated for ferrying missions. Every type of USAF aircraft not assigned to a specific unit was ferried from one



O-2As at Hickam AFB (USAF photo.)

unit assignment to another by this organization. Missions of the unit included the movement of all jet fighters from the U.S. (F-84Fs, F-84Gs, F-86Fs and T-33s) over the North Atlantic (transport) Route to U.S. Air Forces in Europe units and Mutual Defense Assistance Program recipients in 1953. It also conducted transfers of F-47 aircraft from Texas to Central and South American countries under MDAP in 1953 and B-57 aircraft to the Far East Air Force in Japan on November 4, 1955.<sup>28</sup> The mission was transferred to TAC on January 1, 1958. Aircraft delivered during this period included the F-100D/F, KB-50J, F-84F, C-130, SA-16, B-66, C-54, C-119C/G, C-47 and B-57. Finally, in the early 1960s, the 4440th ADG assumed control of 431st Air Refueling Squadron after inactivation of 4505th Air Refueling Wing with KB-50 tankers. The 4440th during the 1960s was responsible for the movement of USAF aircraft to South Vietnam and Thailand bases to support the war. The unit delivered aircraft like the F-4, F-100, F-105, A-37 and various FAC O-2 and OV-10 aircraft. They also delivered F-4, F-111 and F-105 aircraft to NATO during this same period until the unit was finally deactivated on October 15, 1969.<sup>29</sup>

As a result of the O-2 navigational incidents, the last one occurring on May 19, 1967, and the fact the O-2 aircraft had no autopilot to reduce pilot workloads, the WAS aircrews received additional training on the O-2 aircraft's modified fuel and lubricant systems. This aftermarket fuel system included the addition in cabin of two 90-gallon and one 60-gallon fuel tanks which replaced all of the aircraft seats except the left front seat for the pilot.<sup>30</sup> Because of the O-2's design, the removal of the right front seat and placement of the 60-gallon fuel tank in the front of the aircraft meant the pilot had to climb over the extra fuel tank, as well as a newly installed high frequency radio next to the fuel cell, to enter and exit the aircraft.<sup>31</sup> Additionally, the pilots were also provided an extra cabin 5-gallon engine oil tank and hand-pump.<sup>32</sup> According to Paul Hoffman, one of the contract pilots:<sup>33</sup>

*Here again the emphasis was on safety. The examination which followed was on fuel systems and the problems which*



O-2 prior to extended fuel tank installation, Paul Hoffman standing in front, date 1967. (Paul Hoffman, "Ferrying a Fighting Skymaster to Vietnam," *The AOPA Pilot*, Vol. II, no. 3, March 1968.)

*might arise, such as fuel pump failure, etc., and what to do for an anticipated emergency.*

Each pilot was also provided with all of the instrument flight rules and visual flight rules' charts, flight plans and instrument approach charts for the U.S., Pacific and Southeast Asia areas, as well as the Pacific Airman's Guide and even a large supply of traveler's checks to cover any unanticipated expenses.<sup>34</sup> The pilots also received a briefing from a 4440th ADG aircrew survival expert on the nearly 40 items issued in the overwater survival kits (including a water survival immersion suit) that the pilots would carry during the transoceanic crossing.<sup>35</sup> When a group of four WAS pilots had completed their aircraft checkouts and had been issued all needed items, the four would report back to McConnell AFB and were issued their aircraft. The pilots then departed as a formation of four aircraft for the 1200 nautical mile journey to Hamilton AFB, north of San Francisco, California, where the pilots would rest and mechanics would recheck the aircraft for their first of six overwater legs to South Vietnam.<sup>36</sup>

## Duckbutt

The Pacific air ferry route flown by the WAS crew was initially designated "Flying Fish" and later changed to "Cornet West," going from California (Hamilton AFB) to Hawaii (Hickam AFB), then to Midway broadcasts in a scene later reminiscent of the 1970 movie "Tora, Tora, Tora," helping provide an ADF bearing for the crews the closer they flew to the islands.<sup>48</sup> After an average of fourteen hours and ten minutes in the air, the O-2s would touch town at Hickman AFB, where the crews were received by another 4440th ADG unit, the 4440-1st Detachment, that helped provide billeting, meals, transportation, refueling and maintenance support to the O-2 flight.<sup>49</sup> A day later the WAS crews departed for the next two legs of the journey, starting first with the 1,140 nautical mile leg to Midway Island, followed by another approximately 1,025





O-2A of the 20th TASS taxiing for takeoff, Hue Citadel Air Field, July 1967 (USAF photo.)

nautical mile leg crossing the international date line to Wake Island, where a 4440th ADG officer was forward deployed at each island to help facilitate the aircrews' movements. One WAS pilot kept himself mentally busy over the long stretch of open water by counting all the meters, switches, knobs, buttons, controls, and warning lights in the O-2 cockpit.<sup>50</sup> Before arriving at Wake Island, because the airfield there was administered by the Federal Aviation Administration, the 4440th ADG officer was required to call ahead and schedule block times for refueling and parking the O-2 aircraft overnight.<sup>51</sup>

After departing Wake Island, the next day the remaining legs involved the 1,300 nautical mile trip to Guam, where the aircrews were met by another 4440th ADG representative with the 4440-11th detachment based on the island's Andersen Air Force Base.<sup>52</sup> At this point in the Vietnam War, Guam served as a primary staging area for B-52 bombers conducting raids on Vietnam, so it was here the arriving WAS pilots received their first glimpse of the U.S. military's direct involvement in Southeast Asia. After a day's rest in Guam the WAS crews were briefed for the next-to-last leg of the deployment, the ten-hour or 1,389 nautical mile trip to Clark AFB, Philippine Islands. Upon arriving at Clark AFB, the WAS pilots were directed by the Philippine's-based 4440th ADG's 4440-15th detachment operations team to fly to the Manila International Airport 20 air minutes away. It was there that the local Cessna dealer had aircraft mechanics reconfigure the aircraft for delivery to the USAF in Vietnam.<sup>53</sup> This reconfiguration consisted of removing all the O-2 cabin fuel tanks, pumps, etc., installing the necessary equipment for use in Vietnam that had been removed before the ferry flight, then reinstalling the one cabin gas tank for the flight to Vietnam.<sup>54</sup> Once the O-2's modifications were completed the aircraft were flown back to Clark AFB to prepare for the final push to South Vietnam.

## Nha Trang

In preparation for the 881 nautical mile trip from Clark AFB to the USAF's Nha Trang Airbase located on the South-Central Coast of Vietnam, the WAS aircrews re-



O-2A with weapons load out, date unknown. (USAF photo.)

ceived a classified briefing on escape and evasion procedures in case they crashed or were shot down over Vietnam. As part of this briefing, the pilots were issued a map with the positions of all USA special forces camps in-country and a special folder with information on what to do if they inadvertently flew over communist countries.<sup>55</sup> One note that highlighted the potential dangers of flying into South Vietnam was printed at the bottom of the aforementioned map:<sup>56</sup>

*One important point, no [U.S.] evader, however desperate might be his need for assistance, should ever attempt to approach a [U.S. special forces] camp at night.*

The WAS aircrews also received classified briefings on the names, locations and frequencies of the different radar sites in South Vietnam along with the standard flight folder with air routes. These briefings included ditching procedures near the South Vietnam coast, frequencies and call signs, IFR departure and approach procedures, airfield diagrams and parking plans at Nha Trang.<sup>57</sup> One map in particular, shown during the WAS aircrew briefing, caught the attention of many a pilot with no military experience:<sup>58</sup>

*On the wall in the briefing room was a large map of Vietnam with different colored circles on it. The yellow circles represented area that our gunfire extended in the air up to 16,000 feet. The blue circles around most the airports [in South Vietnam] represented the areas protected by [U.S.] Army Hawk [short-range air defense] missiles. In the event of [a possible North Vietnamese air attack], get out of that area fast because the Hawk missiles are not very selective and will shoot down anything in the area.*

Departing later that day as a flight of four aircraft from Clark AFB, the WAS aircrews would begin the last leg of their trip from Wichita to South Vietnam, where upon arrival the O-2s would be officially transferred to the 20th TASS for deployment around the theater of operations. The reality of being in a combat zone was obvious to many a WAS pilot on landing at Nha Trang, as Paul Hoffman would write:<sup>59</sup>



WAS Pilot (name not known) exiting an extended fuel tank equipped O-2, date 1967. (Paul Hoffman, "Ferrying a Fighting Skymaster to Vietnam," *The AOPA Pilot*, Vol. II, no. 3, March 1968.)

*As I walked away to get a picture of the [O-2] planes together just as they were on the ramp back in the [United] States at the Cessna plant, the smoke in the background and the muffled booms of the artillery and mortar fire were a constant reminder of the almost unbelievable fact that I was in [South] Vietnam.*

Once the O-2 aircraft were transferred to the 20th TASS the aircrews would begin their journey back to the United States for another ferry mission. According to WAS pilot John Lear, son of Learjet founder William "Bill" Lear, the return leg to Wichita was also an adventure itself.<sup>60</sup>

*Arriving in Nha Trang we would hitch a ride to Saigon and spend three days under technical house arrest each trip, pay a fine for entering the country illegally, that is being civilians and not coming through a port of entry, catch an airline up to Hong Kong for a little R&R [rest and recuperation] and [go] straight back to Wichita for another airplane.*

While the 4440th ADG's deployment of the initial delivery of 191 O-2 Skymasters by WAS pilots was very successful and helped meet the USAF's increasing operational needs in South Vietnam, there were some significant operational and safety challenges related to the deployment of so many aircraft over the vast distances of the United States and Pacific Ocean. First, the fact that many of the O-2 production models were not equipped with long-range or tactical air navigation systems greatly hindered the de-



WAS Pilots planning their next leg at Clark AB, Philippines, in 1967. Note the pilot on the left wearing civilian sneakers. (Paul Hoffman, "Ferrying a Fighting Skymaster to Vietnam," *The AOPA Pilot*, Vol. II, no. 3, March 1968.)

livery of aircraft into Hamilton AFB during north central California's fall and winter months.<sup>61</sup> Second, it was reported by the 4440th operation officers that some WAS pilots were reluctant to write up items which would ground aircraft and referred to the O-2 aircraft "as is" if considered flyable.<sup>62</sup> Third, arrival dates were not always synchronized with WAS aircrews departing on a Friday and arriving at Hamilton AFB on a Saturday when most of the base's contract maintenance facilities needed to prepare the O-2 aircraft for the transoceanic crossing were closed.<sup>63</sup> All of these challenges were quickly addressed by Colonel Bush's team and the crossings continued until the 4440th's last O-2 aircraft was delivered to Nha Trang via the Cornet West routing on March 13, 1968 by Gail Poulton, vice president of World Aviation Services.<sup>64</sup>

As with any deployment of many aircraft over long distances, statistical mishaps may occur and unofficially this was the case with the O-2 Project's deployment. According to one source, three accidents occurred during the delivery of the O-2s from Wichita, Kansas to Na Trang, Vietnam, though only one of these mishaps, a July 19, 1967 ditching of an O-2A aircraft 415 nautical miles west of Midway, was reported in the 1967 4440th ADG's official unit histories.<sup>65</sup> Appearances aside, the O-2 aircraft were not "technically" USAF aircraft and would not be officially until they arrived in Vietnam and were formally delivered and accepted.<sup>66</sup> Since the O-2s were technically not US government aircraft, any mishap at the time would not be reported in USAF documentation. Additionally, as the O-2s were not registered as civil aircraft they could not have a recordable civil accident either; they were in regulatory limbo and any accidents were technically non-reportable.<sup>67</sup>

The story of the O-2 Skymasters in Vietnam does not end with their deployment in-country, as the aircraft's worth was proven many times over both by U.S. and, later, South Vietnamese pilots flying FAC missions across Southeast Asia in support of ground forces. The O-2s would continue to serve to the end of the South Vietnam conflict with a number of O-2s redeploying back to the United States via USAF transport aircraft and others being left behind, like the 35 O-2s transferred to the Republic of South Viet-



nam Air Force prior to the 1975 fall of Saigon.<sup>68</sup> Regardless of the outcome of the war, the work and dedication of the USAF airmen, Cessna employees and WAS pilots working together as a team to find an effective and inexpensive way

to ferry nearly 200 small aircraft across the United States and Pacific Ocean is a story that needs to be told accurately for the benefit of these airmen, their families and aviation history.<sup>69</sup> ■

## NOTES

1. Walt Shiel, *Cessna Warbirds*. News release, 2021. [https://www.goodreads.com/book/show/1036231.Cessna\\_Warbirds](https://www.goodreads.com/book/show/1036231.Cessna_Warbirds) (accessed October 1, 2021).
2. *An Eye to the Sky: Cessna*. (Wichita, KS: Cessna Incorporated, n.d.), pp. 40-41.
3. *Ibid.* p. 45.
4. *Ibid.*
5. *Ibid.*, p. 67.
6. Centerline thrust aircraft was not a new concept and dates to the early days of aviation. Known originally as a “push-pull” configuration, the concept was used by aircraft designers. The advantage it provides is the ability to mount two propellers on the aircraft’s centerline, thereby avoiding the increased drag that comes with twin wing-mounted engines. It is also easier to fly if one of the two engines fails, as the thrust provided by the remaining engine stays in the centerline. In contrast, a conventional twin-engine aircraft will yaw in the direction of the failed engine and become uncontrollable below a certain airspeed. Historical examples include Dornier’s Do Wal flying boat and Do 335 Pfeil fighter, as well as a number of French Farman and Dutch Fokker aircraft built in the 1920s and 1930s.; Jeffrey L. Rodengen, *The Legend of Cessna*. (Fort Lauderdale, FL: The Write Stuff, 1998), p. 139.
7. Jeffrey L. Rodengen, *The Legend of Cessna*, p. 140.
8. Chris Chant, ed. *The World’s Air Forces*. (Secaucus, NJ: Chartwell Books, 1979), p. 206.
9. Jeffrey L. Rodengen, *The Legend of Cessna*, p. 140
10. *FM 44-30, Visual Aircraft Recognition*. (Washington, D.C.: U.S. Government Printing Office, October 1986), pp. 8-10 – 8-11.
11. Other names for the O-2 aircraft included: Duck, Mixmaster, Push-Pull, Cessna Suck-Blow, The B.S. Bomber (Nickname for O-2B psychological warfare variant). “Cessna O-2 Super Skymaster”, *War Bird Alley*, 2016. <http://www.warbirdalley.com/o2.htm> (accessed November 01, 2021).; Jeffrey L. Rodengen, *The Legend of Cessna*, p. 144.
12. Jeffrey L. Rodengen, *The Legend of Cessna*, pp. 144-45.
13. Donald J. Mrozek, *Air Power and the Ground War in Vietnam*. (Maxwell AFB, Ala.: Air University Press, January 1988), p. 109.
14. John Guilmartin, Jr., and Michael O’Leary. *The Illustrated History of The Vietnam War: Helicopters*. (New York: Bantam Books, 1988), pp. 33-34.
15. *U.S. Air Force Factsheet: FAC In SEA: Foreword Air Control Aircraft*. [https://web.archive.org/web/20121013112510/http://www.nationalmuseum.af.mil/factsheets/factsheet\\_print.asp?fsID=5575&page=1](https://web.archive.org/web/20121013112510/http://www.nationalmuseum.af.mil/factsheets/factsheet_print.asp?fsID=5575&page=1) (accessed November 21, 2021); Some O-1/L-19s were armed with four to 8 2.75” rockets. The USAF carried White Phosphorus while the USA O-1’s fired high explosive warheads. Chris Mayer, Aircraft owner and historian, Email message to the author, June 26, 2022.
16. Walt Shiel, *Cessna Warbirds: A Detailed and Personal History of Cessna’s Involvement in the Armed Forces*. (Iola, WI: Jones Publishing, Inc., 1996), p. 213.
17. *U.S. Air Force Factsheet: FAC In SEA: Forward Air Control Aircraft*.
18. Cessna O-2A Skymaster, <https://web.archive.org/web/20080801213153/http://www.nationalmuseum.af.mil/factsheets/factsheet.asp?id=304> (accessed November 21, 2021).
19. Richard H. Wood, “How the O-2s Really Got to Vietnam,” *Night Rustics*, 2000. <https://nightrustics.org/Delivery.htm> (accessed November 2, 2021).

20. The Fort Benning, Georgia-based battalion’s four-week voyage to Qui Nhon, South Vietnam went via Mayport, Florida, the Panama Canal Zone, Hawaii, Guam and the Philippines. Benjamin S. Silver. *Ride at a Gallop*. (Waco, TX: Century Alpha Inc., 1990), pp. 268-69.
21. John Guilmartin, Jr., and Michael O’Leary. *The Illustrated History of The Vietnam War: Helicopters*, p. 29.
22. The C-133 Cargomaster aircraft was particularly well-suited for this task as it was originally designed to carry large U.S. Air Force Thor intermediate range ballistic missiles to Europe and later used to transport US Army UH-1 Huey helicopters to South Vietnam. *Ibid.*, p. 25.
23. Paul Hoffman, Jr., “Ferrying A Fighting Skymaster to Vietnam,” *The AOPA Pilot*, Volume II, No. 3, March 1968, p. 44.
24. WAS Flight Leaders were paid \$1000 per trip, with the line pilots receiving \$800 per trip. The pilots were expected to average three trips a month. Richard H. Wood, “How the O-2s Really Got to Vietnam”, *Night Rustics*, 2000.; Since the O-2s were in a technical sense “public” aircraft (as opposed to civil registered aircraft) no pilot’s license was necessary to fly one for the USAF. Paul Hoffman, Jr., “Ferrying A Fighting Skymaster to Vietnam,” *The AOPA Pilot*, p. 44.
25. “O-2A/B Deployment”, Telex Message, May 26, 1967, *History of the 4440th Aircraft Delivery Group, Langley AFB, Virginia, 1 January – 30 June, 1967*. (Langley Air Force Base, VA: United States Air Force, 1967), pp. 1-2, U.S. Air Force Historical Archives, Maxwell AFB, Ala.
26. “O-2 Deliveries Placed Under 4440th Control,” *History of the 4440th Aircraft Delivery Group, Langley AFB, Virginia, 1 January – 30 June, 1967*. (Langley Air Force Base, VA: United States Air Force, 1967), p. 2, U.S. Air Force Historical Archives, Maxwell AFB, Ala.
27. “Unit Timeline,” *History of the 4440th Aircraft Delivery Group, Langley AFB, Virginia, 1 July 1967 – 31 December 1967*. (Langley Air Force Base, VA: United States Air Force, 1967), n.p., U.S. Air Force Historical Archives, Maxwell AFB, Ala.
28. “Squadron/1738/Ferrying,” *Air Force History Index.Org*. <http://airforcehistoryindex.org/data/000/494/640.xml> (accessed November 26, 2021).
29. “1708th FW/FG-4440th ADG,” *Super Saber Society*. <https://units.supersabresociety.com/emblems/1708th-fg-fw/> (accessed November 26, 2021).
30. Paul Hoffman, Jr., “Ferrying A Fighting Skymaster to Vietnam,” *The AOPA Pilot*, p. 44.
31. In an emergency, the O-2 pilot could exit the left side of the aircraft by using the pilot station’s emergency exit window. “Emergency Exits, Entrances, and Equipment,” *T.O. 1L-2A-1, Flight Manual USAF Series O-2A and O-2B Aircraft*. (Washington, D.C., U.S. Government Printing Office, June 10, 1977), 3-2.; Paul Hoffman, Jr., “Ferrying A Fighting Skymaster to Vietnam,” *The AOPA Pilot*, p. 46.
32. According to *T.O. 1L-2A-1, Flight Manual USAF Series O-2A and O-2B Aircraft*, the *Skymaster* only had oil pressure and oil temperature gauges to monitor the aircraft engine oil lubricant, therefore WAS pilots were directed to track both their oil and fuel consumption during each leg of the flight. Paul Hoffman, Jr., “Ferrying A Fighting Skymaster to Vietnam,” *The AOPA Pilot*, p. 45.
33. *Ibid.*, p. 45
34. *Ibid.*, p. 46.
35. Walt Shiel, *Cessna Warbirds: A Detailed and Personal His-*

tory of Cessna's Involvement in the Armed Forces, p. 218.

36. Hamilton AFB was transferred to the USA in 1983 and formally closed in 1988 as part of the Base Realignment and Closure program. *Ibid.*, p. 47.

37. "Required Conversions of Nicknames (TAC (DAMRDS)) Ltr, 11 July 1968," *History of the 4440th Aircraft Delivery Group, Langley AFB, Virginia, 1 July 1967 – 31 December 1967* (Langley Air Force Base, VA: United States Air Force, 1967), n.p., U.S. Air Force Historical Archives, Maxwell AFB, Ala.

38. P.E. Matt, "The South Pacific Air Ferry Route", *Pacific Eagles, WWII Pacific Air Combat*, December 15, 2015. <https://pacific-eagles.net/the-south-pacific-air-ferry-route> (accessed November 15, 2015).

39. "Memorandum for TAC (DOOS – Colonel Merrill), Subject: O-2 Program Review", 9 October 1967, *History of the 4440th Aircraft Delivery Group, Langley AFB, Virginia, 1 July 1967 – 31 December 1967*. (Langley Air Force Base, VA: United States Air Force, 1967), p. 1, U.S. Air Force Historical Archives, Maxwell AFB, Ala.

40. The surface-to-air recovery system, whereby a rescued aircrew member was attached to a cable under a helium-filled balloon that was "caught" by a low-flying aircraft, was officially known as the Fulton Surface-to-Air Recovery System (STARS) and was made famous in the 1965 James Bond movie *Thunderball*.; Allison C. Brooks. "Aerospace Rescue and Recovery – Southeast Asia to Apollo," *Air University Review, May-June 1967*. <http://www.airpower.maxwell.af.mil/airchronicles/aureview/1967/may-jun/brooks.html> (accessed November 22, 2021), p. 3.

41. Paul Hoffman, Jr., "Ferrying A Fighting Skymaster to Vietnam," *The AOPA Pilot*, p. 47.

42. *Ibid.*, p. 47.

43. One Ocean Station November ship, the USCGC Pontchartrain, was instrumental in assisting with the successful rescue of a Pan Am Boeing 377 Stratocruiser's crew and passengers that ditched in the Pacific Ocean on October 16, 1956. *Ibid.*

44. The Duckbutt aircraft would fly out ahead of the four Skymasters and hold at a position along the course until the flight had passed. *Ibid.*

45. There is some debate whether the 2000 pounds referenced is over the Empty Weight and not the Max Gross Weight. If for no other reason, a lot of the equipment that would be included even in the Basic Empty Weight would not be installed until it arrived in the Philippines or even later. Chris Mayer, Aircraft owner and historian, Email message to the author, June 26, 2022.

46. Paul Hoffman, Jr., "Ferrying A Fighting Skymaster to Vietnam," *The AOPA Pilot*, p. 48.

47. *Ibid.*, p. 44.

48. *Ibid.*, p. 49.

49. *Ibid.*, p. 50.; "4440th Aircraft Delivery Group Organizational Chart," *History of the 4440th Aircraft Delivery Group, Langley AFB, Virginia, 1 July 1967 – 31 December 1967*. (Langley Air Force Base, VA: United States Air Force, 1967), n.p., U.S. Air Force Historical Archives, Maxwell AFB, Ala.

50. The pilot counted exactly 171 items. Paul Hoffman, Jr., "Ferrying A Fighting Skymaster to Vietnam," *The AOPA Pilot*, p. 50.

51. *Ibid.*

52. "4440th Aircraft Delivery Group Organizational Chart," *History of the 4440th Aircraft Delivery Group, Langley AFB, Virginia, 1 July 1967 – 31 December 1967*, n.p.

53. Paul Hoffman, Jr., "Ferrying A Fighting Skymaster to Vietnam," *The AOPA Pilot*, 50.; "4440th Aircraft Delivery Group Organizational Chart," *History of the 4440th Aircraft Delivery Group, Langley AFB, Virginia, 1 July 1967 – 31 December 1967*, n.p.

54. Paul Hoffman, Jr., "Ferrying A Fighting Skymaster to Vietnam," *The AOPA Pilot*, 50.

55. *Ibid.*

56. In 1993, during the author's time as a Survival, Evasion, Resistance, and Escape (SERE) student at the USA's John F.

Kennedy Special Warfare Center and School, Fort Bragg, North Carolina, SERE instructors taught students to wait until daylight before approaching a friendly position in order to avoid a "Blue-on-Blue" or fratricide situation.; *Ibid.*

57. *Ibid.*

58. *Ibid.*, p. 52.

59. *Ibid.*

60. John Lear, who flew ten trans-Pacific O-2 aircraft deliveries, discussed his time working for World Aviation Services during a July 9, 2004 presentation to fellow pilots at the monthly "Hangar of Quiet Birdmen" meeting in Las Vegas, Nevada. Al Morris, "The Adventures of John Lear (son of Bill Lear)," *The Rogue Aviator*, January 3, 2012, <https://therogueaviator.com/the-adventures-of-john-lear-son-of-bill> (accessed November 1, 2021).

61. "O-2 Ferry Operations Review," October 10, 1967, *History of the 4440th Aircraft Delivery Group, Langley AFB, Virginia, 1 July 1967 – 31 December 1967*, (Langley Air Force Base, VA: United States Air Force, 1967), Doc 87, U.S. Air Force Historical Archives, Maxwell AFB, Ala.

62. "O-2 Ferry Operations Review," October 10, 1967, *History of the 4440th Aircraft Delivery Group, Langley AFB, Virginia, 1 July 1967 – 31 December 1967*, Doc 87.

63. "O-2 Program Review." October 9, 1967, *History of the 4440th Aircraft Delivery Group, Langley AFB, Virginia, 1 July 1967 – 31 December 1967*. (Langley Air Force Base, VA: United States Air Force, 1967), p. 2, U.S. Air Force Historical Archives, Maxwell AFB, Ala.

64. *History of the 4440th Aircraft Delivery Group, Langley AFB, Virginia, 1 January 1968 – 30 June 1968*. (Langley Air Force Base, VA: United States Air Force, 1968), p. 6, US Air Force Historical Archives, Maxwell AFB, Ala.

65. The aircraft involved in the ditching incident was an O-2A, serial number 67-21323. According to the 4440th historical records, "The primary cause [of the crash] was pilot error in that the pilot failed to follow established engine failure emergency procedures." The aircraft was lost at sea, but the pilot was recovered uninjured. "Flying Safety Records," *History of the 4440th Aircraft Delivery Group, Langley AFB, Virginia, 1 July 1967 – 31 December 1967*, p. 2.; According to the late Colonel Richard H. Wood, USAF (retired), two additional aircraft accidents occurred during the two-year O-2 Project deployment: The second accident occurred when an O-2 crashed in the Philippines killing the WAS pilot. The third accident involved an O-2 experiencing a hard landing at Hickam AFB. Richard H. Wood, "How the O-2s Really Got to Vietnam", *Night Rustics*, 2000.

66. According to military aviation historian Joe Baugher, approximately eleven O-2 1967 serial numbers are missing from official USAF data bases. The omission of these aircraft serial numbers may indicate that Cessna never officially delivered these airframes to the USAF and validate why the two O-2 aircraft mishaps reported by Colonel Wood are not listed in the 1967 and 1968 4440th unit histories. "USAF Serial Number Search Results, Cessna O-2A", *USASC-USAAS-USAAC-USAAF-USAF Military Aircraft Serial Numbers—1908 to Present*, December 3, 2021, <http://cgibin.rcn.com/jeremy.k/cgi-bin/gzUsafSearch.pl?target=&content=Cessna+O-2A> (accessed December 17, 2021).; Richard H. Wood, "How the O-2s Really Got to Vietnam", *Night Rustics*, 2000.

67. World Aviation Services, Inc. appears to have ceased operations sometime in 2016 and records from the period 1967-68 are were unavailable. The company's current filing status is listed as "Forfeited - Failed to timely file Annual Report" and its File Number is 7031354, "World Aviation Services, Inc.," *Bizapedia*, May 16, 2016, <https://www.bizapedia.com/ks/world-aviation-services-inc.html> (accessed, October 19, 2021).; *Ibid.*

68. "South Vietnam," *Cessna Skymasters used by non-U.S. air forces*, <https://web.archive.org/web/20100312013338/http://www.skymaster.org.uk/military.asp> (accessed November 2, 2021).

69. Walt Shiel, *Cessna Warbirds: A Detailed and Personal History of Cessna's Involvement in the Armed Forces*, p. 218.



# The Man in Black, Coach Pop and Intelligence in the U.S. Air Force



Scott C. Martin

A contemplative Gregg Popovich.

If you were to do a comparative biography between two men, the combination of Johnny Cash and Gregg Popovich might not be an obvious choice. The former known as one of the greatest country-western singers in history and the other establishing himself as an all-time great National Basketball Association (NBA) head coach. Yet should one peel back the onion, you come to find a few similarities. For one, the color black is central to each man's identity. Johnny Cash's main nickname was "The Man in Black" which came from his dressing in black clothing while performing during concerts, as well as the title of one of his top singles. Gregg Popovich, as coach of the San Antonio Spurs, is very much associated with the color black, black and silver being the team colors. The city of San Antonio also connects the two men, as the city played a significant role in Cash's early adult life, where he met his first wife, Vivian Liberto.

Yet, there is another way that San Antonio is significant to Cash, and that factor is also another connection between Cash and Popovich. When Johnny Cash met Vivian, he was there as part of his training when he enlisted in the Air Force in 1950. He completed a seven-week basic training course at Lackland AFB in the summer of 1950, returning in 1951 for follow-up technical training at Brooks Air Base. With Gregg Popovich, his association with the Air Force came with his attendance at the Air Force Academy in Colorado Springs, Colorado. Upon graduation in 1970, he was commissioned an officer in the USAF. Both would serve the Air Force working for some aspect of Air Force Intelligence. Both served during the Cold War, with Russia a primary focus of their professional service/training. Their respective experiences were different, but they played their part in the evolution of the Air Force, the Air Force's and the nation's intelligence capabilities and America's overall role in the Cold War.

## Before the Man In Black, An Airman in Blue...

For Johnny Cash, the idea that he would one day be a part of the growing U.S. intelligence complex seemed unlikely. The son of a poor farmer who settled in Dyess, Arkansas when he was 3, Cash grew up during the darkest parts of the Great Depression, when many in America struggled to put food on the table and maintain a steady employment. Too young to join the fight in World War II, Johnny Cash was old enough to enlist in 1950, right as the U.S. entered the Korean War. For Cash, fresh off a stint at a Ford factory in Michigan, the Air Force offered a chance for adventure and Cash figured that if war with Korea came, and he was drafted, better to be in the Air Force.<sup>1</sup> After taking the oath of enlistment Blytheville, Arkansas on July 7, 1950, Cash took the train from Memphis to San An-

tonio. While in Basic Training, Cash demonstrated strong academic performance, eventually serving as a resource for fellow trainees.<sup>2</sup> Towards the end of his basic training, aptitude tests show Cash showed proficiency needed to become a radio operator. Unsure of what exactly that entailed, the idea of working something with “radio” in the title appealed to him.<sup>3</sup> Upon acceptance as a radio operator, John R. Cash received orders to report to Keesler Air Force Base in Biloxi, Mississippi in late summer 1950.

At Keesler, Cash came to learn more about what a “radio operator” entailed. The job required Cash to learn about how the U.S. eavesdropped on enemy radio communications. The training at Keesler tested his concentration, as he and his classmates learned to sort through radio traffic to decipher Morse code signals, isolate them, transcribe the dots and dashes into letters, and pass them along to translators for decoding.<sup>4</sup> In order to graduate, a trainee had to interpret the codes to produce up to twenty words a minute.<sup>5</sup> In this environment, Cash excelled, advancing through the program ahead of his peers, earning both admiration and envy.<sup>6</sup> His performance, to include his ability to transcribe 26-30 words per minute, also impressed his instructors and superiors, especially the ways that he overcame their efforts to disrupt his ability to decipher signals.<sup>7</sup> As a result, they recruited Cash to join the new USAF Security Service, with posting at one of their key intercept locations.<sup>8</sup> He applied for and was accepted into the Security Service and upon graduation from Kessler was sent back to San Antonio, this time Brooks Air Force Base, for four months of specialized training.

With all the training and dramatic shift in lifestyle, Cash’s life had no shortage of upheaval. Yet his personal upheaval could not match the chaos surrounding the Air Force and the U.S. Intelligence Community as this time. The U.S. Intelligence Community, in its current form, was only a few years old, born from the National Security Act of 1947. As a Morse Code Interceptor/Interpreter, Cash worked focused on Signals Intelligence, or SIGINT. At the time Cash entered the SIGINT world, that discipline, along with the rest of the U.S. Intelligence Community (U.S. IC) was in a tumultuous time. Prior to 1947, The SIGINT capabilities of the U.S. government were mainly the domain of the military services. Each service, primarily the Army and Navy, had their own SIGINT capabilities, and integration between those entities was limited, to include how each service reported and analyzed the collected SIGINT, and what days each service worked on the SIGINT.<sup>9</sup> The confusion and chaos only increased with the establishment of a



Airman J. R. Cash, radio operator trainee.

new branch of service. The Air Force officially entered the SIGINT game with the establishment of the U.S. Air Force Security Service (USAFSS) on October 20, 1948.<sup>10</sup>

For the National Intelligence Community, having three separate SIGINT entities, all controlling their own personnel, resources and operations, this proved untenable. Given that the USAFSS could not adequately perform its critical mission of tracking and reporting on Soviet Long Range Aviation, especially in Europe, due to manning and equipment shortfalls, the U.S. faced serious issues on how it could leverage its intelligence capabilities.<sup>11</sup> To try to better control the disjointed SIGINT efforts and better resource the SIGINT enterprise, the Department of Defense established the Armed Forces Security Agency (AFSA), with the expressed goal of directing and controlling U.S. SIGINT operations, mainly communications intelligence (COMINT).<sup>12</sup> AFSA did leave tactical-level requirements up to the respective services, but much of the overarching guidance was to come from AFSA.<sup>13</sup> However, due to ineffective leadership and a severe lack of control of resources (mainly financial and personnel), the respective services still maintained a high degree of autonomy when it came to SIGINT activities.

This disorganization and bureaucratic infighting did little to help the U.S. deal with its primary concern of analyzing and reporting on the activities of America’s key rival: The Soviet Union. The former World War II allies now faced off in a geo-political contest with world supremacy at stake. At the start of the what became the Cold War, the U.S. found itself at a significant disadvantage when it came to insight about the USSR. Various

*Scott Martin is an active-duty USAF officer with over 20 years of service. He received his BA from Trinity University and his MS in International Relations from Troy University. He has written for multiple publications to include Air Power History, Air and Space Power Journal and Strategic Studies Quarterly.*



efforts for U.S. spies to infiltrate the USSR yielded little success. In the late 1940s, the U.S. government was desperately looking for any information on the USSR, to include searching for a Soviet phone book. In most cases, the U.S. had to rely on its limited ability to intercept Soviet communications.<sup>14</sup>

This restriction only became tougher when on October 29, 1948, the USSR switched its high-level communications code, rendering much of the previous reporting stream useless, a date that NSA would later refer to a “Black Friday”.<sup>15</sup> As a result, U.S. SIGINT collection on the USSR had to come from lower level government communications and Morse intercepts of Russian aviation/military units. From these, the U.S. and its allies could obtain some insight into Soviet capabilities and intent. When it came to long-range aviation, that fell under the control of the USAFSS, and as a result, men like Johnny Cash were called to focus on that activity.

What Johnny Cash might have known about the turmoil within the U.S. SIGINT community is uncertain, but this was the environment he walked into as he started his life as a Morse Code operator. Upon leaving his final training at Brooks AFB, he was assigned to 6912th Security Squadron, stationed in Landsberg, Germany. For Cash, this was the optimum assignment. His talent with Morse intercept and his record of excellence set him up for such a prime tasking. Additionally, Germany seemed far most appealing than the other option of Adak, Alaska.<sup>16</sup> With all of that resolved, Cash departed for his new adventure on Sept 20, 1951, leaving Brooklyn Naval Yard for the long trek to Landsberg, Germany.

Upon his arriving to Germany, Cash reported to the 6912th Security Squadron, with specific assignment to the 12 Radio Squadron Mobile (RSM). For the next three years, Cash’s work life consisted of working eight hour shifts on the second floor of a secure facility (nowadays known as a Secure Compartmentalized Information Facility (SCIF)) with no windows. With their workspace filled with coffee and cigarettes, Cash and his cohorts (up to thirty-nine other operators) listened in on headphones, trying to pick up the activities of Soviet bombers and air defense units tracking U.S. aircraft.<sup>17</sup> Cash’s musical aptitude served him well, as he could pick out the tone of the Morse communications he sought. Once he had the signal, he quickly typed out the interpretation of the Morse, which in turn was relayed to linguist and cryptographers to translate/analyze.<sup>18</sup> Cash’s work enabled him to identify specific transmissions, which he sometimes named, such as “Ol’ Goober.”<sup>19</sup>

While not on the combat lines like his counterparts in Korea, Cash’s life did not lack for stress. Many a smoke/coffee break was interrupted with various cryptographers racing into the room to indicate another plane launched. Tensions between divided Europe remained high, with Germany seen as the front line for a possible major conflict, one that could go nuclear very quickly. The long hours of work and the stress of working in such tight/enclosed places could wear down the toughest of Morse operators. On multiple occasions, an opera-

tor might just suddenly “lose it”, and act funny, from crying, shouting, or ramming their heads into doors.<sup>20</sup> Even Cash confessed to losing his cool one night, throwing one of the typewriters across the room, before being escorted out for a break.<sup>21</sup> While others do not recall a specific incident like this and Cash did have a habit of embellishing his previous actions, many of his compatriots did have troubles with the stressful work. Shift work and high stress environments can wear workers down, even in the present-day military. However, Cash continued his work, with generally exceptional results.

By the time that Cash’s tour ended in 1954, Staff Sergeant Cash was more than ready to leave. The primary diversions of the airmen at Landsberg, booze and women, had worn thin with Cash. He still maintained his loyalty to Vivian (save a few encounters with German women early in his time at Landsberg), even inviting her to live with him toward the end of his tour in late 1953. His work still focused on the activities of Russian Air and Air Defense units. This included intercepting the first flight of a Soviet jet bomber from Moscow to Smolensk.<sup>22</sup> However, perhaps his biggest achievement was more on the geo-political realm. According to Cash, one of his Morse intercepts in April 1953, revealed the announcement of the death of Josef Stalin. The strongman ruler of the USSR since 1927, Stalin was in failing health, but that information was not common knowledge. This particular account, part of the Cash legend, has not been verified by official sources. Given that most of the Western World only learned about his death from the wire services when the USSR made the official announcement (with no reference to the stroke that had incapacitated him for hours prior to his death), it is hard to say that Cash truly broke that news, or if he did, it did not go beyond Air Force cryptologic channels, given the tactical focus of their mission.<sup>23</sup> The Air Force wanted Cash to stay, but while in Germany, his passion for music had outgrown his desire to serve in the Air Force, and in April 1954, he separated, starting down the path of country music superstardom.

### **Before Coach “Pop”, Cadet/Lt Popovich**

By the 1970s, Johnny Cash’s Air Force days were a distant memory, as he took his place atop the country music world. However, for Gregg Popovich, his Air Force experiences were in full swing. The son of Serbian and Croatian immigrants, Popovich grew up honing his basketball skills in the basketball-mad state of Indiana, eventually able to parlay that talent and his academic record into an appointment to the Air Force Academy. At first, Popovich did not have visions of military glory, but was more looking for a place to play ball on scholarship. From 1968-1970, Cadet Popovich starred on the Air Force Academy basketball team, leading the team in scoring and assists during his senior season (his record for career shooting percentage of 54.1 percent is 3rd all-time in the Air Force Academy basketball records as of 2022).<sup>24</sup> Upon graduation from the Academy, Popovich



U.S. Air Force Academy cadet Gregg Popovich.

commissioned as a 2nd Lieutenant on June 3, 1970.

Given that the Air Force lacked an Air Force Specialty Code (AFSC) for basketball player, Popovich was designated for a different service track. At the Academy, he learned that he would be assigned as an 8054, the designation for an Air Force Intelligence Officer.<sup>25</sup> It was a field that fit in line with his academic studies, as he was taking classes in Soviet Studies. Upon his commissioning, Popovich received his first assignment to the 6594th Support Group at Sunnyvale, CA.<sup>26</sup> Being a freshly-minted 2nd Lt, it is likely he didn't get too involved with the technical mission of the base, working initially in the administrative arm of the base while awaiting technical training.<sup>27</sup> Still, he would have had some exposure to the mission of the base, which was a part of the Air Force's Space and Missile Systems Organization, which had oversight on the U.S. military's forays into space, which included Intelligence, Surveillance and Reconnaissance (ISR) satellites.<sup>28</sup> From there, 2nd Lt Popovich's next foray would be for more technical training. However, his basketball prowess would move him along a different career path than his peers, as the commanding general for the U.S. Armed Forces basketball team assigned the former point guard to his team.

Much like Johnny Cash, Popovich entered military service at a chaotic time for the nation and the intelligence community. As with Cash twenty years prior, Popovich entered active duty while the U.S. was engaged in major combat operations, this time in Vietnam. While the U.S. was reducing its presence in Vietnam, it still loomed as a possible focus for Popovich's service. As with Cash, while an East Asian nation might be the primary

focus of fighting, there still existed a major threat that overshadowed all: The Soviet Union. No longer quite the mystery it was during Cash's time in service, the USSR still posed significant challenges for intelligence operations. While the leadership was different (Stalin vs. Brezhnev) and there were some signs of improved relations with *detente*, both superpowers still postured their militaries to face-off in a possible nuclear conflict. Only now, the weaponry advanced to the point that each nation could destroy the other without a single soldier setting foot on the soil of another country, between advances in aircraft, submarines and ballistic missiles.

As for the U.S. IC, much had changed, but it was still a community rife with bureaucratic squabbles. The old AFSA, never able to consolidate its position among the services, eventually gave way to the National Security Agency (NSA) in 1952, which took the lead for national SIGINT policy. The military services still held control of specific missions, but the NSA proved a stronger organization vs. its AFSA predecessor. Along with a strong organization, NSA oversaw a significant increase in SIGINT capabilities, from more advanced technical means of collection to increased personnel for analysis and reporting. Between the times of SSgt Cash and 2nd Lt Popovich, the NSA grew into a massive entity, with an operating budget over \$1B and over 93,000 military personnel assigned at the time of 2Lt Popovich's commissioning.<sup>29</sup> Of note, the USAFSS still served as the Air Force service component supporting NSA and the national SIGINT enterprise, not changing its name until 1990.

One of the biggest advances for the intelligence community came from the increased role space was playing in national defense. Whereas Cash and his counterparts relied on collection from ground-based sensors and were mainly concerned about air and land-based threats, the world of the 1970s also had to contend with threats from and transiting through space. The Soviet launch of Sputnik in 1957 opened the gateway to space as the next frontier of the Cold War. The advent of Intercontinental Ballistic Missiles (ICBMs) posed a greater existential threat, with large missiles able to deliver lethal nuclear payloads across the globe within thirty minutes with little to no warning. The tracking of launchers and missile command and control proved one of the highest priorities of the intelligence community in the 1970s.

Additionally, the U.S. IC used space to increase collection of Soviet targets. While the U.S. still used traditional aircraft to collect against Soviet targets, the U.S. began using ISR satellites to collect on targets deep inside the Soviet Union. Traditional aircraft, equipped with cameras for IMINT and SIGINT sensors, still flew, but after Gary Powers' U-2 was shot down in 1960, along with other reconnaissance aircraft downed near Soviet territory, space-based assets seemed a safer bet.<sup>30</sup> Starting in 1960, the U.S. used space-based satellites to collect and analyze imagery of targets deep in Soviet territory.<sup>31</sup> From the mid-1960s, imagery and SIGINT satellites were launched with the purposes of gathering



intelligence without the risks associated with regular aircraft. Operated by the then-covert organization of the National Reconnaissance Office (NRO), these ISR satellites, part of the Corona program, provided critical imagery and signals intelligence to U.S. policymakers and military leaders as they continued to posture against the Soviet Union.<sup>32</sup>

For 2nd Lt Popovich, much like SrA Cash, what he knew, or was aware of the various developments and backstory for is not known for sure. Popovich, notorious for being tight-lipped in his on and off-court interviews, has said little about his time in the service and even less about his non-basketball experiences. He is more open about his experiences on the Armed Forces Basketball team, which he played on as part of a Goodwill tour in 1972. During that time, Popovich travelled throughout several cities in the USSR, to include Moscow, Kiev, Vilnius, Tbilisi and Tallinn. Popovich, despite his designation as Air Force Intelligence, likely did not have the training to make professional assessments of what he saw, but he came to learn a great deal in his time on that trip.<sup>33</sup> He would also see other parts of the Warsaw Pact. After the Goodwill Tour, Popovich returned to his regular Air Force duties, with his next assignment slated for Turkey.

In 1973, now 1st Lt Popovich received an assignment to Diyarbakir Air Station, Turkey. This remote location housed equipment and satellites for tracking Soviet weapons activity out of Kapustin Yar, one of their main weapons testing locations. Given the location deep in Soviet territory, the U.S. had to rely on a combination of long-range ground sensors (mainly to track launch activity) and space-based assets (Imagery Intelligence (IMINT), Measurements and Signals Intelligence (MASINT) and SIGINT) to determine activity at the site. Popovich, in what little he has publicly revealed about the site, noted that upon his arrival, he was greeted by a screaming, joyous man, later revealed to be the lieutenant he was slated to replace.<sup>34</sup> However, there would be no tales of mental breakdowns or struggles, ala Cash, as Popovich recounted fond memories of interactions with the Turkish natives. It is unknown if Popovich did shiftwork, but at sites that require the ability to monitor and report on military activity 24/7, it is entirely possible that Popovich worked and/or supervised individuals who had to work shifts to provide the required coverage. Those airmen would have been a combination of radar technicians, SIGINT analysts and other experts with training in monitoring and reporting on weapons/space activities.

However, his future would not lie in the intelligence world, but on the hardwood, as the Air Force Academy recalled their former start point guard to start him on his path towards coaching. In late 1973, Popovich returned as an assistant coach. From there, the rest is well-documented in the sports pages, going from the Air Force Academy to coaching at a Division III college, to eventually working in the front office of the San Antonio Spurs, before taking over as head coach before the 1996-

1997 season, a position that he still holds to this day, 5 titles and 1480 combined wins later (as of the end of the 2020-2021 NBA season).<sup>35</sup> His Air Force career saw him move into the Air Force reserves, which he honorably separated from in 1983 as a Major (his final posting at March AFB).<sup>36</sup> He was inducted into the Air Force Academy Hall of Fame in 2019 (more for his basketball success rather than in his intel background). While Popovich may not reflect a great deal on his specific work while in the service, he does continue to cite his time at the Academy and in the Air Force as a source of pride and educational experience on leadership.

## Conclusion/Comparison

When discussing the lives of Johnny Cash and Gregg Popovich, both men have much to add to their biographies. When Cash passed away in 2003, he left the stage as perhaps the greatest country western performer of all time, and nearly seventeen years later, Cash's work still enralls audiences of all ages. For Popovich, the book on his NBA career is far from over. While the Spurs have not won a title since 2015, his teams still contend for playoff berths at a constant rate, a difficult achievement given the fluctuations in teams and players from year to year. They are Hall-of-Famers in their primary professions, but both looked back on their relatively short time in the Air Force with a degree of pride. They served at the beginning of their respective adult lives, leveraging the direct and indirect lessons that the Air Force could teach an individual (enlisted and officer) to set themselves up for the future successes their lives would follow.

Yet, there Air Force careers, in different tracks and times, have important parallels. Both served in the long-running Cold War, with the threat of all-out nuclear warfare with the USSR never far from fruition. With neither saw direct combat, their daily work focused on monitoring the activities of the key Cold War adversary, helping to maintain that delicate strategic balance that kept both sides from slipping into war. The technological advances in the sixteen years between Cash's discharge and Popovich's commission saw incredible advancements in technology and capabilities. Yet, the focus of the Morse Operator Cash was ultimately not that much different than Lt Popovich and his supervision of analysts in Turkey. Both monitored the offensive capabilities of the Soviet Union, analyzing and reporting on their weapons capabilities, looking to see if the USSR was just exercising, or perhaps, mobilizing for conflict. While Cash worked a single-source intelligence discipline of SIGINT, as compared to Popovich, whose mission focus would work with multiple intelligence disciplines, both mission still tied back to the USSR and their weapons capabilities.

It is likely that Cash's aptitude for Morse, detecting audio patterns to find the right frequency would have served him well in the Space Age, as overhead satellites in the 1960s and 1970s still collected on military communications like the ground-based sensors of the 1950s.



Johnny Cash in his Air Force uniform hanging out with a Hawaiian-shirted friend.

Concurrently, while Popovich might never have done the specific work that Cash did as an enlisted operator, it is likely that Popovich would have led a group of Morse

radio operators and cryptographers with the same dedication to detail and personal empowerment he brings to the hardwood with the Spurs. Yet, for both men, an Air Force career was never the long-term goal. When their time in service was up, both men took the lessons from the Air Force, and moved on to the next, greater chapter of their lives.

Yet, both men also played their part in the continuously evolving role of the U.S. Intelligence Community. What was a chaotic series of organizations, with competing agendas and diverse offices, has continued to evolve into a massive enterprise with a worldwide focus, supporting all facets of the U.S. government, from military to homeland security. While both men saw the eventual fall of the Soviet Union, Russia still remains a major focus of the U.S. IC. Even today, analysts work on tracking and reporting on Russia weaponry, from aviation to space-launched weapons, noting advancements in technology and employment, all while trying to maintain the precarious balance of peace. Like the Cold War, Russia is not the only focus of the IC, and the interagency competition, with services vs. specific agencies and agencies vs. each other, continues. However, the core missions, the ones that faced Cash and Popovich still apply in 2022, as their fellow airmen continue to work as a part of the Department of Defense and the U.S. IC, monitoring and reporting on the actions of adversaries of all types. ■

## NOTES

1. Robert Hilburn, *Johnny Cash: The Life*. (New York: Little, Brown & Company, 2013), p. 27.
2. *Ibid*, p. 30.
3. *Ibid*.
4. *Ibid*, p. 31.
5. Michael Streisguth, *Johnny Cash: The Biography* (Philadelphia, PA: De Capo Press, 2006), p. 40.
6. Hilburn, *Johnny Cash: The Life*, p. 31.
7. Streisguth, *Johnny Cash: The Biography*, p. 40.
8. *Ibid*.
9. Stephan Budiansky, *Code Warriors: NSA's Codebreakers and the Secret Intelligence War Against The Soviet Union* (New York: Alfred C. Knopf, 2016), p. 90.
10. United States Air Force, "The Twenty-Fifth Air Force (ACC)" US Air Force, accessed 30 April 2020, <https://www.af.mil/About-Us/Fact-Sheets/Display/Article/1397250/the-twenty-fifth-air-force/>.
11. Matthew M. Aid, *The Secret Sentry: The Untold History of the National Security Agency*, (New York: Bloomberg Press, 2009), p. 20.
12. *Ibid*
13. *Ibid*.
14. *Ibid*, p. 24.
15. Matthew M. Aid and Cees Wiebes, "Introduction: The Importance of Signals Intelligence in the Cold War" *Intelligence and National Security* 16, p. 1 (Mar 2001), p. 18.
16. Hilburn, *Johnny Cash: The Life*, p. 34.
17. Streisguth, *Johnny Cash: The Biography*, p. 41.
18. *Ibid*, p. 43.
19. *Ibid*.
20. Hilburn, *Johnny Cash: The Life*, p. 41.
21. *Ibid*, p. 42.
22. Alan Light, *Johnny Cash The Life and Legacy of the Man in Black*. (Washington D.C., Smithsonian Books, 2018), p. 48.
23. Aid, *The Secret Sentry*, p. 45.
24. Sports Reference College Basketball "1969-70 Air Force Falcons Roster and Stats" Sports Reference, accessed 11 June 2021 at Air Force Leaders & Records - Season | College Basketball at Sports-Reference.com.
25. Gregg Popovich Military History (Freedom Of Information Act) accessed 30 April 2020, <https://www.documentcloud.org/documents/1311561-spurs-coach-gregg-popovich-military-history.html>.
26. John Tedesco and Tom Orsborn "Air Force Life for Popovich: Spy Satellites and Basketball" San Antonio Express News, 25 Oct 2014, <https://www.expressnews.com/sports/spurs/article/Air-Force-life-for-Popovich-Spy-satellites-and-5848368.php>.
27. *Ibid*
28. *Ibid*
29. Aid, *The Secret Sentry*, p. 148.
30. Colonel John Hughes-Wilson, *The Secret State: A History of Intelligence and Espionage*, (New York: Pegasus Books, 2016). pp. 177-9
31. *Ibid*, p. 189.
32. *Ibid*.
33. Tedesco and Orsborn, "Air Force Life for Popovich".
34. *Ibid*
35. Basketball Reference "Gregg Popovich" accessed 11 June 2021, <https://www.basketball-reference.com/coaches/popovgr99c.html>.
36. Gregg Popovich Military History.



# Command, Control, and Communications of Bomber Forces in World War II and the Korean War

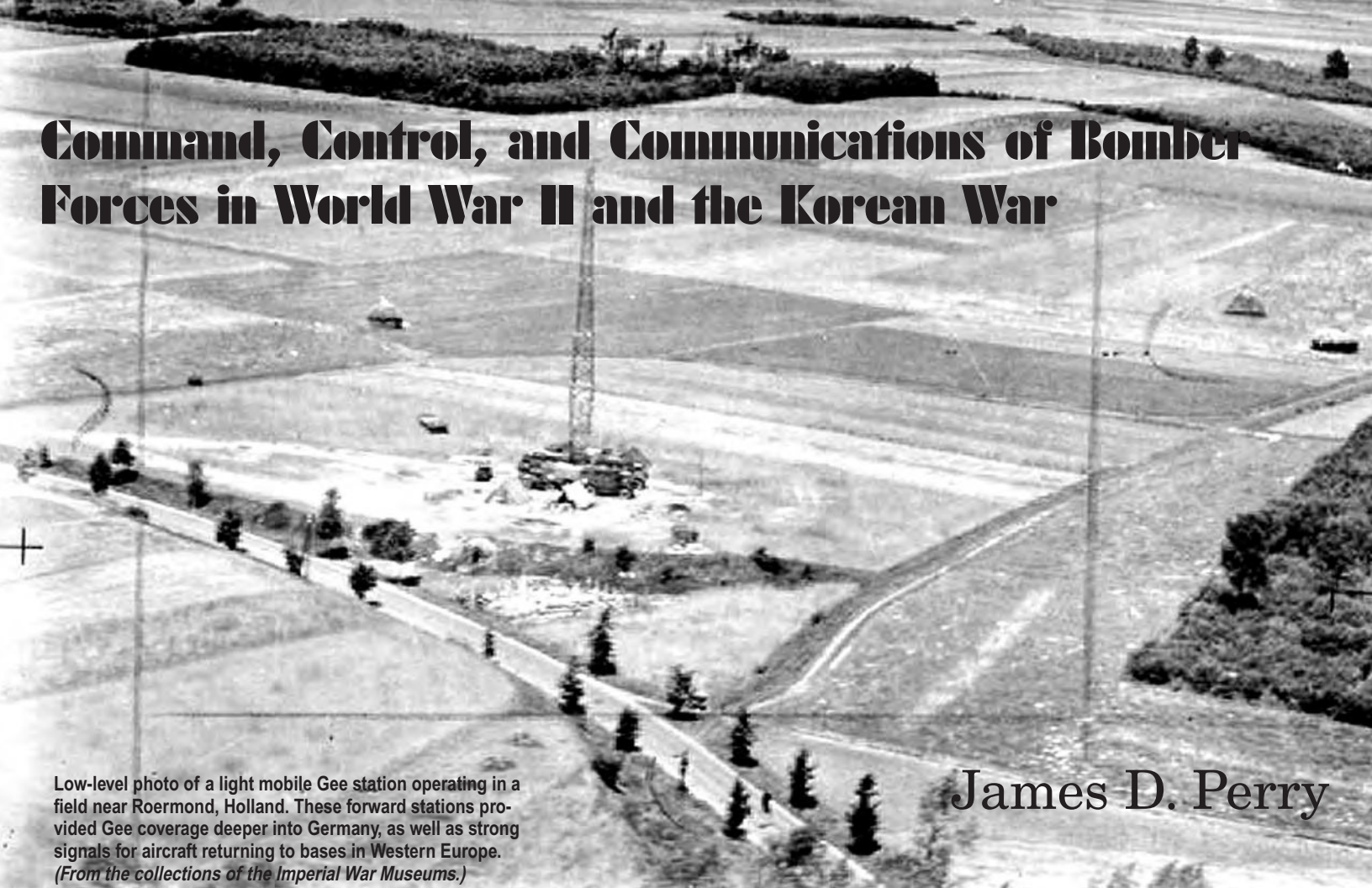

Low-level photo of a light mobile Gee station operating in a field near Roermond, Holland. These forward stations provided Gee coverage deeper into Germany, as well as strong signals for aircraft returning to bases in Western Europe. (From the collections of the Imperial War Museums.)

James D. Perry

**C**ommand, control, and communications (C3) of bomber forces in World War II and the Korean War receives relatively little attention from historians. The apparent assumption is that bombers, unlike fighters, needed little if any information or direction from base after they took off. Although bombers were not directed from the ground like fighters on interception missions, bombers still needed effective communications with each other, with fighter escorts, and with their bases. For this purpose, bombers used Very High Frequency (VHF) radio for short-range communications, and High Frequency (HF) radio for long-range communications with their base. Bombers received navigational assistance from ground-based radio beacon systems such as Gee, Gee-H, LORAN, and SHORAN. The bombing campaigns would have been far less effective without effective C3. Communications with the ground and with other aircraft were critical for bomber survivability and for improving bombing accuracy to the limits possible with the available technology.

## Operational and Tactical C3 in Europe

In Europe, the Combined Chiefs of Staff issued general targeting directives to Spaatz to guide his employment of Eighth and Fifteenth Air Force.<sup>1</sup> A combined Anglo-American committee recommended weekly target priorities based on the latest intelligence information. The Eighth Air Force representative on this committee passed these recommendations to the Combined Operational Planning Committee, which chose and planned the daily bombing missions.<sup>2</sup> The day before an attack, planners used weather reports to determine which targets to attack and how to attack them. The planners sent a field order to the combat units, specifying routes, timing, altitude, geographic check points, formations, aim points, enemy defenses, and other pertinent information. Each unit involved used the field order to brief their crews. Very detailed planning and a rigid timetable was needed because large numbers of aircraft had to assemble and fly in formation.<sup>3</sup>

Missions were tightly scripted, but the targets were fixed – factories, marshalling yards, airfields, etc. Ground control did not need to update the bombers about the target location after take-off. The principal information the bombers needed was weather over the target, and P-51 “weather scouts” went ahead to determine it. Mission plans included alternate targets in case bad weather precluded visual attacks on the primary target. If weather was poor over every target, the formation could either bomb non-visually or seek a target of opportunity. Typically only six days per month were suitable for visual bombing. Bombers dropped a high percentage of their bombs non-visually (see Fig. 1).

Bombers used radio-navigational aids that were based on measuring the difference in the time of arrival of pulses sent from ground beacons to determine the aircraft’s position. Gee had a range of 300 to 400 miles, and was only accurate



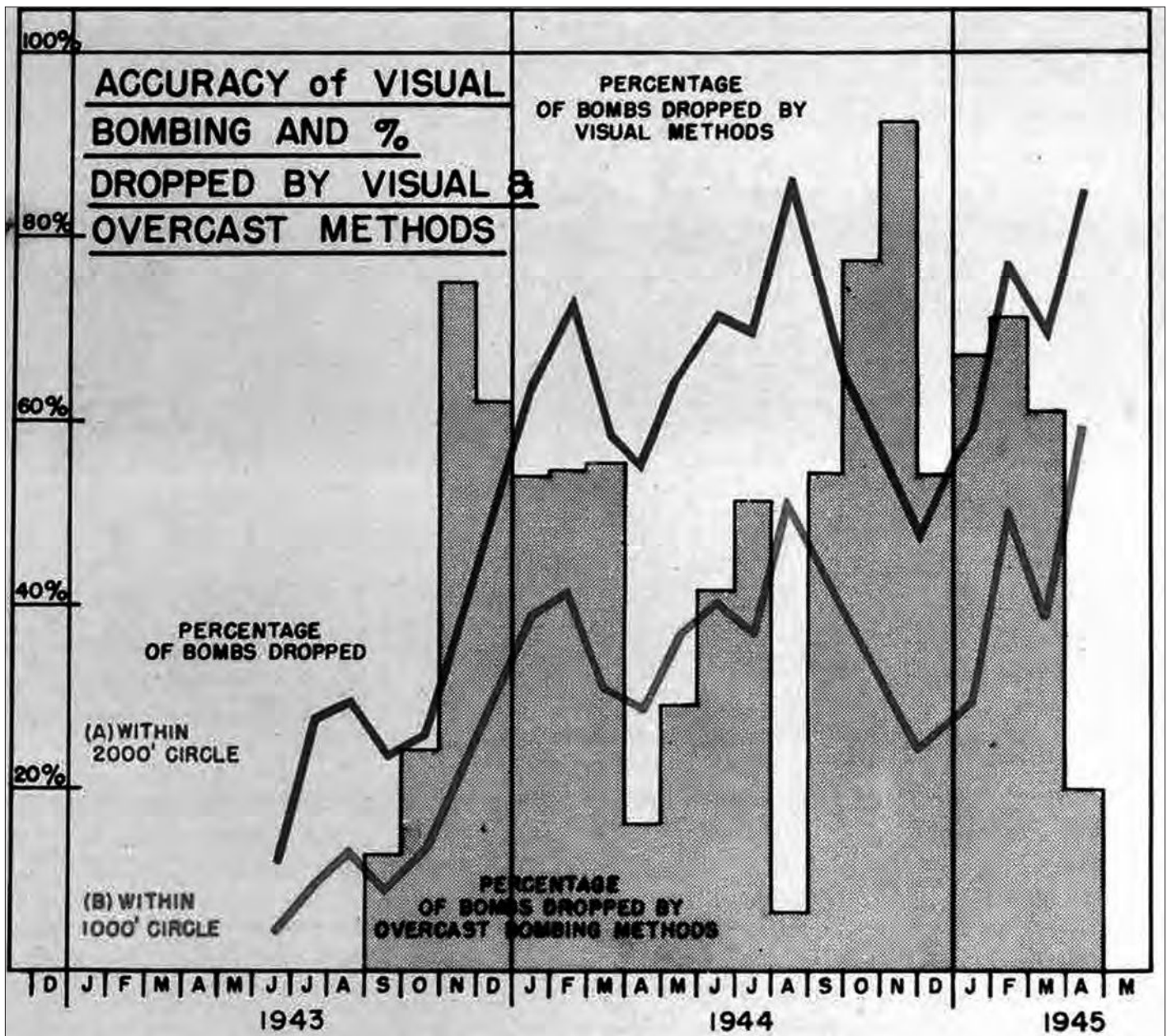

Figure 1: Percentage of visual and overcast bombing per month, and the accuracy of bombing for each method. (Eighth Air Force, Eighth Air Force Tactical Development: August 1942 – May 1945, July 9, 1945, p. 63.) (Source for figures 1, 3, 4 and 7 is <https://cgsc.contentdm.oclc.org/digital/collection/p4013coll8/id/4112/>)

enough for general navigation.<sup>4</sup> Gee-H sent pulses from the aircraft that triggered ground stations to send answering pulses to the Gee-H receiver on the aircraft. Two beacons created range arcs that intersected over the target (see Fig. 2). The bombardier released the bombs after a predetermined period of time based on altitude, speed, and type of

bomb carried. Accuracy decreased with distance from the beacons. Gee-H was used extensively against targets like V-weapon sites prior to D-Day. In September 1944, the Allies moved Gee-H beacons to the continent to facilitate accurate bombing deeper into Germany.<sup>5</sup>

Bombers used H2X airborne radar to assist navigation by detecting visible features such as rivers or lakes. H2X was particularly useful against coastal targets (see Fig. 3). In November 1944, Eighth Air Force began using Micro-H, which combined Gee-H and H2X. Micro-H had to be used within range of ground beacons, but was much more accurate than H2X alone (see Fig. 4).<sup>6</sup> Even with these aids, overall accuracy was poor. Only 20 percent to 40 percent of Eighth Air Force bombs fell within 1,000 feet of the target.<sup>7</sup>

Ground control rarely issued direct orders to airborne bombers after take-off. An exception was to recall them due

*James D. Perry has an M.A. in Security Policy Studies and a Ph.D. in History from George Washington University. After obtaining his Ph.D., he was a Visiting Fellow at the Hoover Institution on War, Revolution, and Peace. He is a Senior Analyst for Northrop Grumman Corporation, where he conducts research and analysis to support company aircraft programs. He is the author of numerous articles on military history.*



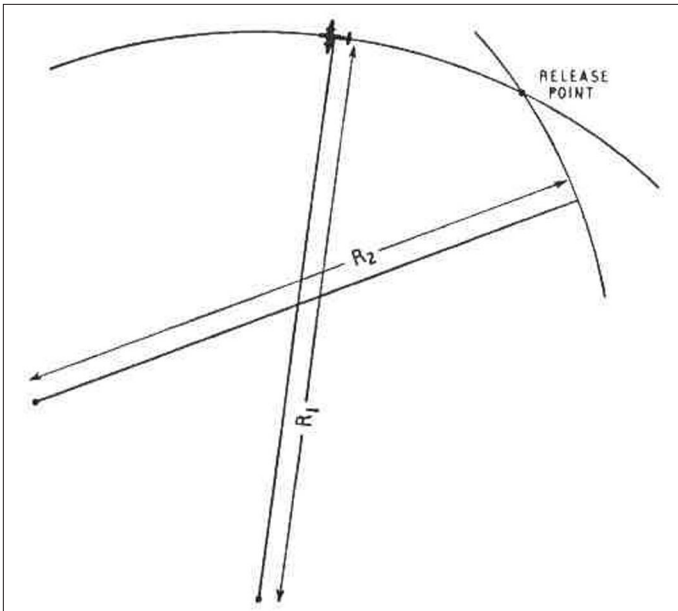

Figure 2: For blind bombing with Gee-H, the aircraft flew along an arc of a circle at a constant distance from one Gee-H beacon. When the range to the second beacon reached a previously calculated value, the beams intersected over the target, and the aircraft had reached the release point. (Brig. J. D. Haigh, *The Services Textbook of Radio, Volume 7, Radiolocation Techniques* (London: HMSO, 1960), online at <http://www.radarpages.co.uk/mob/navaids/geeh/geeh1.htm>)

to bad weather. When bombers returned to base, however, voice and radio-navigational communication with the ground was critical. Ground control directed returning bombers to their home fields, or to alternate fields if weather was poor at the home field. Damaged aircraft were guided to emergency fields. If a bomber ditched in the sea, ground control guided air-sea rescue to the bomber's last known location.

The SCR-522 was the standard Very High Frequency (VHF) voice radio carried in American fighters and

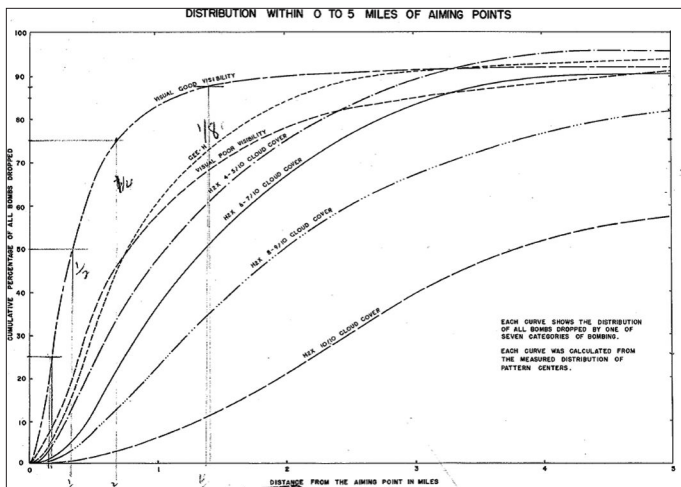

Figure 4: Accuracy of Eighth Air Force bombing methods, 1 September to 31 December 1944. Only 24% of the bombing effort took place under visual conditions, and 35% of the effort was under "blind" (10/10 cloud) H2X conditions. Operational Analysis Section, HQ Eighth Air Force, "Report on Bombing Accuracy, Eighth Air Force, 1 September to 31 December 1944," 20 April 1945, pp. 66-75. The lethal radius of the standard 500 pound bomb was a few tens of feet against industrial targets. (McFarland, p. 186.)

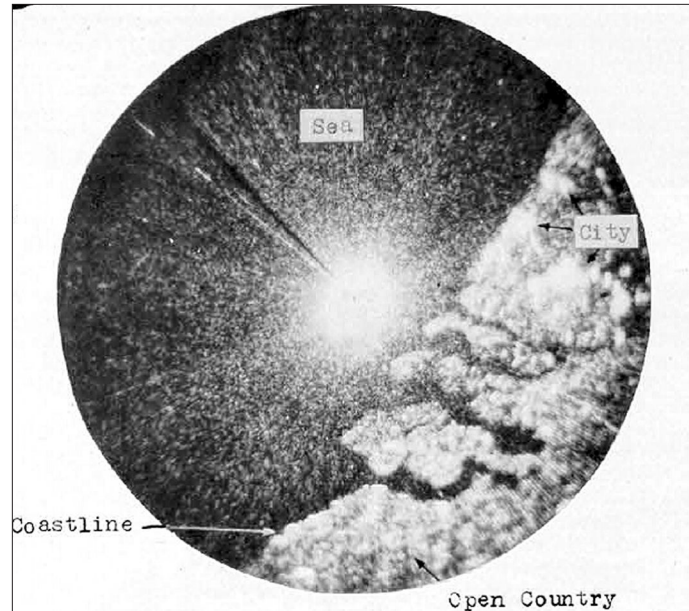

Figure 3: H2X image showing the contrast between ocean, city, and open country. (Eighth Air Force Tactical Development August 1942 – May 1945, p. 66.)

bombers (see Fig. 5).<sup>8</sup> The SCR-522 had four channels. The first channel was on a frequency assigned to the individual Group for use in combat and to communicate with ground control during return to base. The second was the common air-sea rescue channel. The third was used to coordinate between bombers and their escorts. The fourth was the "fixing" channel that enabled ground control to triangulate the aircraft's position when it was within radio range of British bases.<sup>9</sup> American bombers also carried the SCR-287 High Frequency radio that was principally used to send and receive long-range messages in Morse code. Range depended on atmospheric conditions and time of day. B-29 operators over Japan used HF radio to communicate with their bases over 1,500 miles away. Transmission and reception speed depended on operator skill, but was typically fifteen to twenty words per minute.<sup>10</sup>

A basic hindrance to the command and control of aircraft was lack of "over the horizon" VHF voice capability. Depending on aircraft altitude, controllers in Britain could reach pilots up to 150 to 200 miles away – not much farther than the Dutch coast. Nor could radars in Britain provide situational awareness over Germany itself. The "over the horizon" C3 capability was needed in order to control the fighter escorts. Fighter escorts typically worked in relays (see Fig. 6). When one fighter unit returned to base, another fighter unit took over. In principle, this could be completely pre-planned. In practice, both bombers and fighters experienced delays that prevented them from being at a rendezvous point at the appointed time. This created a gap in escort coverage that the Germans could exploit. Controllers needed precise, complete, and continuous information on the location of the bombers, their escorts, and the enemy in order to direct the escorts.<sup>11</sup> The USAAF solved this problem in three ways.

Firstly, bombers reported their own positions. Radio silence was impractical and unnecessary. The German early

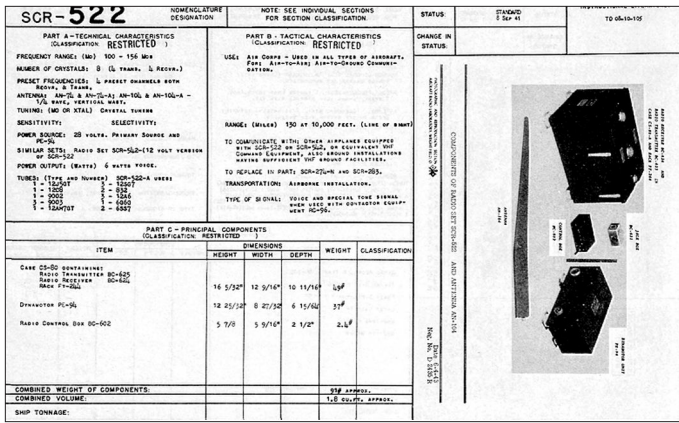
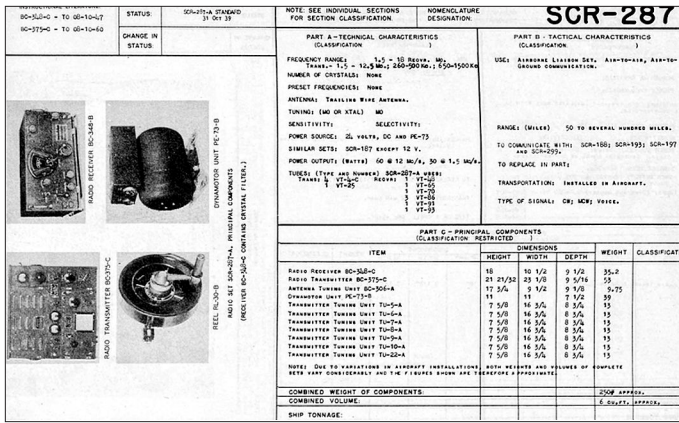

Figure 5: The SCR-522 and SCR-287 radios. (Online at [https://radionerds.com/images/c/c/SCR-522\\_Data.png](https://radionerds.com/images/c/c/SCR-522_Data.png) and [https://radionerds.com/index.php/File:SCR-287\\_Data.png](https://radionerds.com/index.php/File:SCR-287_Data.png))



warning system was so good that they knew where American aircraft were even if they maintained radio silence. Accordingly, bombers reported to base when they reached geographical control points such as the English coast, the enemy coast, and easily recognized lakes or towns (see Fig. 7). These reports enabled the control room to build a "mission progress map" showing the location of all units.<sup>12</sup> Eighth Air Force fighter control was the first to plot mission progress, but Eighth Air Force HQ and the bomber units soon realized its utility.<sup>13</sup>

The next source of information about the location of friendly units was the enemy himself. The Luftwaffe broadcast a "running commentary" in order to tell their fighter pilots where American aircraft were. German aircraft shadowed bomber formations and broadcast their size, course, and escort status. British signals intelligence intercepted these transmissions and passed the product to Eighth Air Force within a minute of receiving it; thus, "the Germans were obligingly giving us a most detailed running commentary on the positions of our bombers and fighters over Reich territory."<sup>14</sup> The Germans often reported the bomber positions more accurately than did the bombers themselves. Signals intelligence was also used to reposition escorts if necessary. Of course, controllers had to make it sound like their warnings came from different sources than signals intelligence.<sup>15</sup> In 1944, Eighth and Fifteenth Air Force bombers carried German-speaking radio operators who listened to German radio chatter during the mission

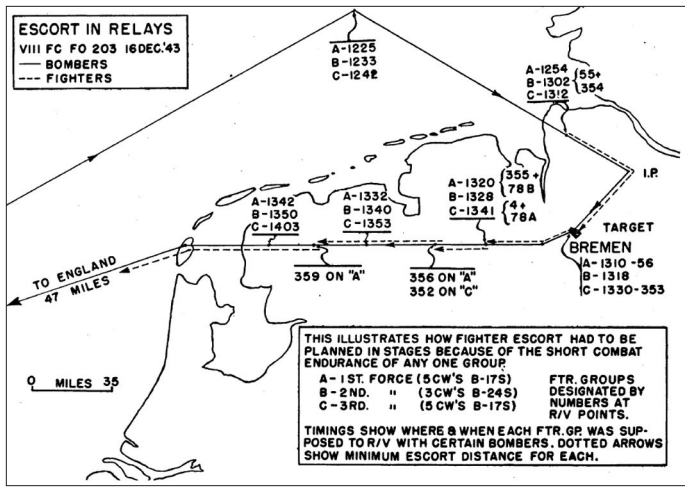

Figure 6: Escort in Relays. (65th Fighter Wing, "Colgate Calling: Offensive Strategic Fighter Control, ETO, 1943-45," June 1945, p. 62.) (Source for figures 6 & 8 is <https://cgsc.contentdm.oclc.org/digital/collection/p4013coll8/id/4627/>)

in order to warn bomber crews when an enemy attack was imminent.

Finally, Eighth Air Force used airborne relays. At first, fighter pilots over the North Sea repeated messages that they heard from aircraft over Germany. Later, bombers over the North Sea were equipped with special radios that automatically relayed voice communications between ground control and aircraft over Germany. Each bomber provided relay services for up to six fighter groups.<sup>16</sup> By late 1944, airborne relays permitted controllers to communicate with aircraft as distant as Berlin (see Fig. 8).

In November 1944, an SCR-584 Microwave Early Warning (MEW) radar was installed in Holland. Its 200-mile range provided coverage over much of western Germany. This radar supported a forward fighter control center known as "Nuthouse." Nuthouse informed friendly aircraft of the position and altitude of enemy aircraft, steered escorts to their rendezvous with the bombers, and vectored escorts to attack enemy fighters. Pilots especially valued Nuthouse for its assistance with poor-weather navigation. Even with Nuthouse, Eighth Air Force still maintained the system of bomber self-reporting, signals intercepts, and relay bombers, because many missions penetrated beyond the range of the MEW radar.<sup>17</sup>

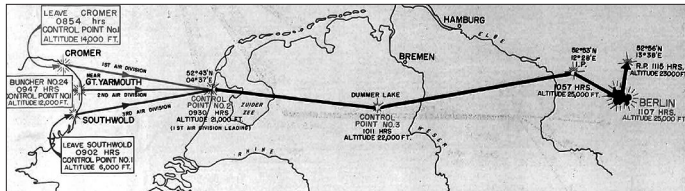
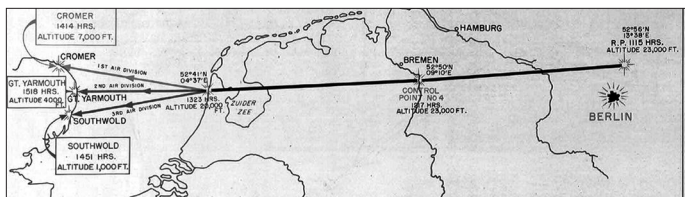

Figure 7: Mission to Berlin (March 1945) ingress and egress routes with control points. (Eighth Air Force Tactical Development August 1942 - May 1945, p. 44.)





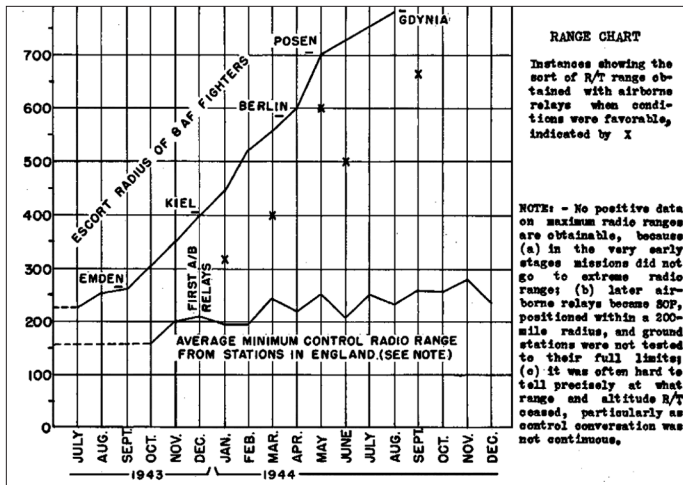

Figure 8: Radio relay aircraft enabled Eighth Air Force to control fighter forces over Germany from bases in Britain. (*"Colgate Calling," p. 86.*)

The Eighth Air Force C3 system was essential to bomber survivability because it permitted the direction of the long-range escorts that protected the bombers. The system increased crew survival because it enabled ground controllers to guide bombers back to base in bad weather and to direct air-sea rescue forces to downed aircraft. Radio navigational aids enabled bombers to bomb far more effectively than they could have through purely visual means.

### Operational and Tactical C3 in the Pacific

Twentieth Air Force had very different communications requirements from Eighth Air Force. Bombers flying from Britain spent six hours in heavily defended German airspace. In contrast, bombers launched from the Marianas spent seven hours crossing the Pacific and one hour in comparatively lightly defended Japanese airspace. Fighter escorts based on Iwo Jima had very limited endurance over Japan. Thus, Twentieth Air Force, unlike Eighth Air Force, did not need a communications system to coordinate its fighters and bombers over enemy territory. The principal information the bombers needed from base was radio navigational guidance for their flights to and from Japan.

General Arnold issued targeting directives to Twentieth Air Force.<sup>18</sup> Based on these directives, XXI Bomber Command issued field orders that specified the targets, routes, altitudes, initial points, aim points, axis of attack, bomb loads, timing, and other pertinent information. Each Wing determined how to achieve the objectives of the field order and briefed its crews accordingly.

Typically, crews maintained radio silence during the mission. On some night missions, a B-29 flew ahead of the main force, orbited over the target, and broadcast a homing signal to the rest of the Wing. Sometimes a "wind determination aircraft" preceded the strike force, and broadcast the wind direction and velocity over the target at three minute intervals using VHF voice.<sup>19</sup> This information improved accuracy. On night incendiary missions, sometimes pathfinders started fires to guide the main force. Each Wing designated one aircraft to transmit a Morse code "strike report" over HF radio after the attack. The report stated the time of the attack, the

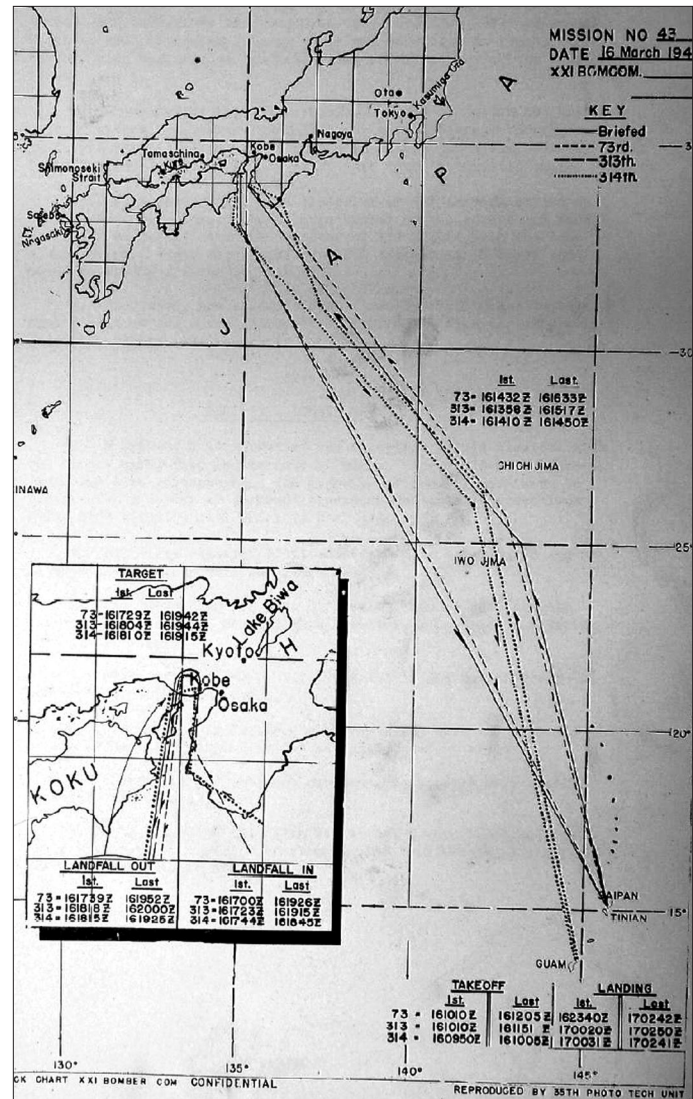

Figure 9: Navigational track of the 16 March 1945 mission to Kobe. Night missions launched from the Marianas in the early evening and returned fourteen hours later. All three Wings reached the target roughly simultaneously to saturate the defenses. The aircraft only spent about 45 minutes out of their 14 hour mission in enemy airspace. (*HQ XXI Bomber Command, "Tactical Mission Report: Mission No. 43, Flown 16 March 1945," 19 April 1945.*) (Source for figures 9 & 10 is <https://www.cooksontributet29.com/uploads/5/8/6/5/5865941/56590008-21st-bomber-command-tactical-mission-report-43.1-32.1-16.pdf>)

target, the method of bombing (visual or radar), bombing results, cloud cover, and enemy opposition.<sup>20</sup>

For night missions, B-29s navigated individually to the target. They flew at low altitude and without defensive armament to increase their bombload. Each aircraft used radio pulses from Long Range Navigation (LORAN) transmitters on Guam and Saipan to determine its position. Over water at night, LORAN could be received for 1,500 nautical miles – roughly the distance from the Marianas to Japan. Daytime LORAN range was much less. Skilled operators could fix their position to within 1.5 miles at 1,400 miles from the transmitter.<sup>21</sup> B-29s took thousands of LORAN fixes during operations against Japan.<sup>22</sup>

The bombers used airborne radar for navigational assistance. Planners chose routes that passed near easily recognizable islands or landmarks (see Fig. 9). Typically, the

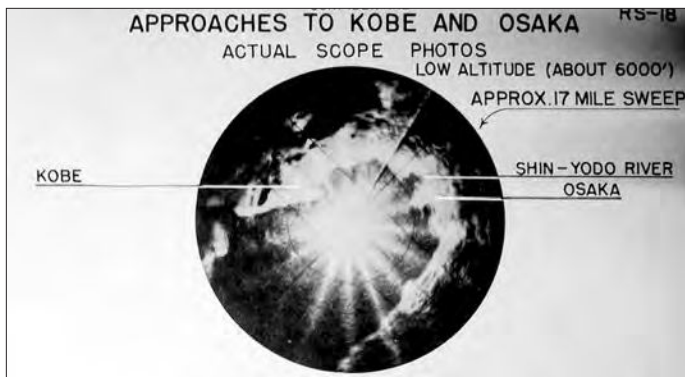

Figure 10: Twentieth Air Force field orders included radar photos of the target and its approaches in order to familiarize radar operators with their appearance. (HQ XXI Bomber Command, "Tactical Mission Report: Mission No. 43, Flown 16 March 1945," 19 April 1945.)

initial point and axis of attack were chosen for radar visibility. Many Japanese cities were on the coast and easily visible on radar (see Fig. 10). During day missions, the B-29s did not fly in formation until they got within enemy fighter range. If there was a fighter escort, navigator B-29s led the escorts to the target area and then home again after the mission, using VHF radio as necessary.<sup>23</sup>

Weather had a major effect on B-29 operations. Only four days a month were suitable for visual bombing. Jet stream winds produced very high ground speeds that severely reduced the accuracy of high-altitude daylight attacks. A February 1945 daylight attack put seventeen percent of the bombs within 3,000 feet of the target.<sup>24</sup> Medium altitude attacks put thirty percent of the bombs within 1,000 feet of the target.<sup>25</sup> Radar bombing only put ten percent of the bombs within 1,000 feet of the target.<sup>26</sup>

Incendiary bombs did not require pinpoint accuracy. Nevertheless, accuracy was not unimportant; "to assure destruction of the target [bomb] patterns must be spread evenly over the entire area, thus permitting the individual fires started by each ship to merge into a general conflagration."<sup>27</sup> To achieve this effect, planners divided the target into three or four areas. Each had an aim point clearly identifiable on radar and spaced such that 50% of the bombs dropped by each Wing would fall within 2,000 feet of them.<sup>28</sup> Under this system, only three out of 58 cities struck from March to June 1945 had to be re-attacked due to insufficient damage.<sup>29</sup>

The Navy stationed ships and submarines along the bomber route to provide air-sea rescue. Each Wing provided an SB-29 equipped to drop a lifeboat to downed crews. Every point on the bomber route was within four hours sailing time of a vessel or thirty minutes flight time of an orbiting SB-29. Notifications of ditched aircraft went to Wing Headquarters, which alerted rescue forces on Iwo Jima and Saipan. If possible, disabled aircraft communicated with rescue units via VHF voice. Typically, a long-range rescue aircraft orbited over the rescue vessels and directed them to downed aircraft. Air-sea rescue saved over 600 aircrew from 83 downed aircraft from November 1944 to July 1945.<sup>30</sup>

Every half hour for the duration of the mission, ground stations broadcast weather reports and the time via high-

frequency Morse code. To assist returning aircraft, ground stations broadcast a homing signal, and ground control directed the aircraft to their bases. Aircraft landing on Iwo Jima benefited from one of the first Ground Control Approach radars. The controller used this radar and VHF voice to guide the pilots down.

The Twentieth Air Force C3 system was not used to control fighter escorts as in Europe. However, the system increased mission effectiveness by communicating navigational and weather information, and increased crew survival by supporting air-sea rescue efforts and facilitating safe landings in poor weather.

## Bomber C3 in the Korean War

In the Korean War, General MacArthur commanded a joint force that included the Far East Air Forces (FEAF) under General Stratemyer. FEAF Bomber Command consisted of three (and in late 1950, five) B-29 Groups in Okinawa and Japan. Bomber Command typically had sixty or seventy operational B-29s. It flew 20,448 sorties during the war, or about 500 sorties a month.<sup>31</sup> B-29s were principally tasked with "deep interdiction" against railroads, roads, bridges, marshalling yards, supply centers, airfields, and troop concentrations.<sup>32</sup> A joint targeting committee at MacArthur's headquarters selected targets and transmitted them to Bomber Command.<sup>33</sup> Missions were pre-planned, as in World War II, and generally could not be changed within twelve hours before take-off.

The B-29, F-80, and F-86 used the eight-channel AN/ARC-3 radio for VHF voice communications.<sup>34</sup> The B-29 employed the AN/APQ-13 radar for navigation and to strike large industrial targets, but it could not enable blind bombing of small interdiction targets.<sup>35</sup> The B-29s used LORAN for over-water navigation from Okinawa and Japan to Korea, taking fixes from newly-built stations in Japan and near Pusan, Korea.

Short-Ranged Navigation (SHORAN) was a radio-navigational aid employed in Korea to support bombing at night and in bad weather. SHORAN ground beacons enabled B-29s to fix their position. SHORAN had a theoretical accuracy of 50 feet within 200 miles of the beacon. In practice, operator skill and lack of accurate maps of Korea reduced accuracy. The Circular Error Probable of SHORAN bombing in late 1952 was 450 feet, and skilled crews could achieve a CEP of 300 feet.<sup>36</sup> SHORAN operators needed 35 practice drops to become proficient. If a mission commander wished to divert to a secondary target, he could contact the SHORAN stations over HF radio and request reorientation of antennas to the new target.<sup>37</sup> A drawback of SHORAN was that the enemy could predict the arc along which bombers flew to approach the target, and could concentrate the defenses accordingly.<sup>38</sup>

Starting in 1951, Fifth Air Force Tactical Air Direction Posts (TADPs) used ground-based radars to direct air attacks on Communist positions. These included B-29 attacks to disrupt major enemy offensives. Inbound bombers made VHF voice contact with the TADP controller and informed him of their altitude and the types of bombs car-



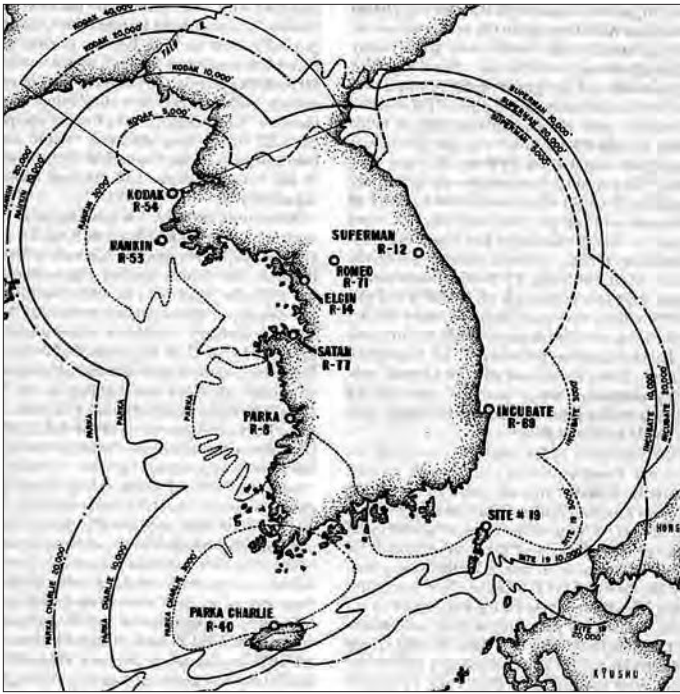

Figure 11: United Nations radar coverage. The station identified as “Kodak” was on the island of Cho-Do that provided coverage of “MiG Alley” and the MiG bases in Manchuria. The communications interception station located on this island guided US fighters to intercept MiGs. (USAF Historical Study No. 127, *United States Air Force Operations in the Korean Conflict, 1 July 1952 – 27 July 1953* (Maxwell, AFB: Air University, 1956), p. 83.)

ried. These transmissions were in the clear, and sometimes enemy voices broke in and tried to misdirect the bomber. The controller directed the bombers to an initial point, where bomb-bay doors were opened, and then counted down to the release point, where the bombs were dropped. Each B-29 typically made four runs and dropped ten 500lb bombs per run. This type of bombing was inaccurate and was not used close to friendly forces except in dire emergency. B-29 radar-directed strikes were best used against area targets, such troops assembling for an attack, and reportedly had a devastating effect on enemy morale.<sup>39</sup>

Bomber attacks in northern North Korea chiefly targeted bridges and airfields. Enemy air defenses consisted of MiG fighters, early warning radars, Ground Control Intercept (GCI) radars, and large numbers of searchlights and anti-aircraft guns.<sup>40</sup> Enemy radars could detect Allied aircraft south of the 38th parallel and support GCI intercepts within 90 miles of the Yalu. The enemy monitored VHF voice transmissions from American aircraft, and used this information to guide MiG attacks.<sup>41</sup>

The UN air defense system included, by February 1952, a radar on an island off the west coast of Korea that provided coverage of Manchuria and “MiG Alley” – the area of northwestern Korea where most air combat occurred (see Fig. 11). This radar could vector friendly fighters.<sup>42</sup> The radar site included a communications interception unit that listened to enemy VHF radio chatter and used this information to vector friendly fighters via VHF voice radio.<sup>43</sup> This was a capability similar to that of the Nuthouse facility in Europe in 1945.

American fighters were typically based near Seoul.

From these bases, F-86 fighters could only remain on station over MiG Alley for about 20 minutes.<sup>44</sup> Sabre formations were dispatched at intervals, and rendezvoused with B-29s at a preplanned time and place. Bomber-to-escort communications were via VHF voice. Typically, eight fighters preceded the bombers, eight fighters flew above the bombers, and twelve fighters flew above and to the rear of the bombers. Thus, twenty-eight fighters were needed to escort four bombers. Other Sabres flew barrier patrols between the bombers and enemy bases in Manchuria. Despite these efforts, the enemy used high-speed, hit-and-run attacks to dive through the escorts and attack the bombers, then broke off and returned to Manchuria. MiGs exploited any opportunities that arose from escorts missing their rendezvous with the bombers, and often attacked when the escorts were running short on fuel. The impracticability of escorting B-29s with jet fighters forced Bomber Command to switch to night operations in 1951.<sup>45</sup>

Communist night fighters were generally ineffective due to lack of airborne radar. Flak was the chief threat to B-29 night missions. To counter enemy flak, Bomber Command attacked in bad weather when clouds blocked searchlights, and compressed the bomber stream to limit time over the target. Direct attacks on enemy radars proved ineffective due to their dispersion, concealment, mobility, and emissions discipline.<sup>46</sup> The bombers employed chaff and electronic countermeasures (ECM) against enemy radars, but did not jam enemy communications because U.S. intelligence was monitoring them.<sup>47</sup>

Bomber Command dispatched “weather scouts” ahead of the main force to determine whether the main force should attack the primary target or a secondary target.<sup>48</sup> Weather scouts were B-29 or B-26 bombers as well as fighter aircraft. They broadcast their information in the clear, presumably using HF radio.<sup>49</sup> When weather over Kadena was bad, ground control used VHF voice to guide returning B-29s to land.<sup>50</sup> The USAF Air-Sea Rescue Service used helicopters and amphibious aircraft to rescue downed crews. Starting in 1952, SB-29s escorted bomber missions between Kadena and Korea. When a B-29 ditched, the SB-29 dropped a lifeboat and informed the rescue control centers of the crew’s location.<sup>51</sup> They used VHF voice to communicate with the downed bomber and rescue forces.

The FEAF Bomber Command C3 system resembled the Eighth Air Force system of World War II more than the Twentieth Air Force system. The Korean War system improved bomber survivability by directing escorts to their bombers. In Korea as in Europe, a critical function of the C3 system was to warn the bombers and escorts about enemy activity using information derived from radars and signals intelligence. The system improved bombing effectiveness, especially at night, with navigational assistance, and increased crew survival by enabling ground control to direct air-sea rescue efforts.

## Conclusion

American bombers in World War II were generally not directly controlled from the ground while conducting their

missions. The Air Force could have created a system for that purpose, if they believed it necessary, because they did create a system for the offensive control of fighters over Germany and over North Korea. Bombers primarily attacked fixed targets, and did not require any updates on the location of the target after they took off. They did, however, require information about weather over the target in order to decide whether or not to attack the primary or alternate targets. Ground control did need to communicate with bombers in order to enable fighter escorts to rendezvous with them. The available communications technology of HF and VHF radio enabled bombers to communicate with fighter escorts, other bombers, and air-sea rescue forces during the mission, to transmit position

and strike reports, and to receive direction from ground control when returning to base. The C3 systems in World War II and Korea provided the bombers with information from ground-based systems that improved navigation. These electronic navigational aids were critically important. Without such aids, the bombers could only have attacked using visual methods for a few days a month, and would scarcely have affected the enemy. Nevertheless, these aids were not accurate enough to enable precision bombing in accordance with pre-war doctrine. The technology that permitted all-weather, day-or-night precision bombing on fixed or moving targets, and the C3 systems that supported today's dynamic targeting, was still well in the future. ■

## NOTES

1. For example, see Wesley Frank Craven and James Lea Cate, *The Army Air Forces in World War II*, Vol. II (Chicago: University of Chicago Press, 1953), pp. 305-307.
2. United States Strategic Bombing Survey, *Aircraft Division Industry Report* (Washington, DC: GPO, 1945), pp. 44-51.
3. Richard Overy, *The Bombing War* (London: Penguin Books, 2013), 350. Donald F. Kilburg, *Hitler's Last Christmas* (Parker, CO: Outskirts Press, 2019), pp. 40-42.
4. W.H. Blanchard, "The Gee System." Online at <http://jproc.ca/hyperbolic/gee.html>
5. Eighth Air Force, *Eighth Air Force Tactical Development August 1942 – May 1945*, July 9, 1945, p. 70.
6. *Ibid.*, pp. 71-72.
7. Stephen L. McFarland, *America's Pursuit of Precision Bombing, 1910-1945* (Washington: Smithsonian Institution Press, 1995), pp. 165-90.
8. George R. Thompson et al., *The Signal Corps: The Test* (Washington, DC: GPO, 1957), pp. 237-41.
9. 65th Fighter Wing, "Colgate Calling: Offensive Strategic Fighter Control, ETO, 1943-45," June 1945, p. 22.
10. War Manpower Commission, "Special Aids for Placing Military Personnel in Civilian Jobs," Washington, DC, February 1944, p. 357.
11. "Colgate Calling," pp. 60-61 and 198-99.
12. *Ibid.*, pp. 68-69.
13. *Ibid.*, p. 74.
14. John Stubbington, *Kept in the Dark* (Barnsley, UK: Pen & Sword, 2010), pp. 234-37, 263-64. "Colgate Calling," p. 77.
15. "Colgate Calling," p. 76. German traffic was so useful that Allied intelligence decided against jamming it.
16. *Ibid.*, pp. 83-84.
17. *Ibid.*, pp. 92-102.
18. Craven and Cate, Vol. V, pp. 553-54 and 572.
19. HQ Twentieth Air Force, "Twentieth Air Force Tactical Doctrine, Night Strikes," 5 September 1945.
20. For example field orders and strike reports, see Robert A. Mann, *The B-29 Superfortress Chronology, 1934-1960* (Jefferson, NC: McFarland & Company, 2009), Appendix 1.
21. J. A. Pierce, "An Introduction to LORAN," *Proceedings of the Institute of Radio Engineers* (May 1946), pp. 220-21. Online at <https://www.americanradiohistory.com/Archive-IRE/40s/IRE-1946-05.pdf>
22. J.A. Pierce, ed., *LORAN* (New York: McGraw Hill, 1948), pp. 37-40. Online at <http://www.introni.it/pdf/04%20-%20Loran.pdf>
23. Office of the Assistant Chief of Air Staff, *Impact: Air Victory Over Japan* (Sept.-Oct. 1945), pp. 69-72.
24. XXI Bomber Command, "Monthly Activity Report," 1 March 1945, p. 8, and 5 April 1945, p. 8.
25. XXI Bomber Command, "Monthly Activity Report," 1 July 1945, pp. 4-5.
26. United States Strategic Bombing Survey, *The Strategic Air Operation of Very Heavy Bombardment in the War Against Japan* (Washington, DC: GPO, 1946), p. 22.
27. Headquarters XXI Bomber Command, "Analysis of Incendiary Phase of Operations, 9-19 March 1945," p. 22.
28. *Ibid.*, p. 23.
29. *The Strategic Air Operation of Very Heavy Bombardment in the War Against Japan*, p. 16.
30. *Impact: Air Victory Over Japan* (Sept.-Oct. 1945), p. 76.
31. *USAF Statistical Digest, Fiscal Year 1953* (Washington: HQ USAF, December 1953), pp. 34 and 36.
32. *Ibid.*, p. 77.
33. Air Force History and Museums Program, *Steadfast and Courageous: FEAF Bomber Command and the Air War in Korea, 1950-53* (Washington, DC: USAF, 2000), p. 12. Robert F. Futrell, *The United States Air Force in Korea, 1950-1953* (Washington, DC: Office of Air Force History, 1983), pp. 50-55.
34. Army Air Forces, "Graphic Survey of Radio and Radar Equipment," March 1945. Online at <https://cdn.shopify.com/s/files/1/1343/9895/files/1945-03-01GraphicSurveyofRadioandRadarEquipmentUsedbytheAAFSection2CommunicationsEquipment.pdf>
35. USAF Historical Study No. 72, "United States Air Force Operations in the Korean Conflict, 1 November 1950 – 30 June 1952," Air University, 1953, p. 180.
36. *Ibid.*, p. 183.
37. USAF Historical Study No. 127, "United States Air Force Operations in the Korean Conflict, 1 July 1952 – 27 July 1953," Air University, 1956, pp. 146-147.
38. USAF Historical Study No. 127, p. 70.
39. USAF Historical Study No. 72, pp. 58-59, 65-66, 196-99. USAF Historical Study No. 127, pp. 185-91, 222-28.
40. USAF Historical Study No. 127, pp. 39-49.
41. Captain Gilles Van Nederveen, "Signals Intelligence Support to the Cockpit," Airpower Research Institute, 2001, p. 11. Online at [http://www.dodccrp.org/events/6th\\_ICCRTS/Tracks/Papers/Track7/012\\_tr7.pdf](http://www.dodccrp.org/events/6th_ICCRTS/Tracks/Papers/Track7/012_tr7.pdf)
42. USAF Historical Study No. 127, p. 54.
43. Van Nederveen, pp. 8-9. David A. Hatch, *The Korean War: The SIGINT Background* (National Security Agency: Center for Cryptologic History, 2000), pp. 13-14.
44. USAF Historical Study No. 72, p. 112.
45. USAF Historical Study No. 72, pp. 114-116.
46. USAF Historical Study No. 127, pp. 248-251.
47. USAF Historical Study No. 127, pp. 72-81.
48. USAF Historical Study No. 71, p. 110.
49. John F. Fuller, *Thor's Legions* (Boston: American Meteorological Society, 1990), pp. 264-66.
50. USAF Historical Study No. 71, p. 94.
51. USAF Historical Study No. 127, pp. 297-99.



# The Cambodian Incursion

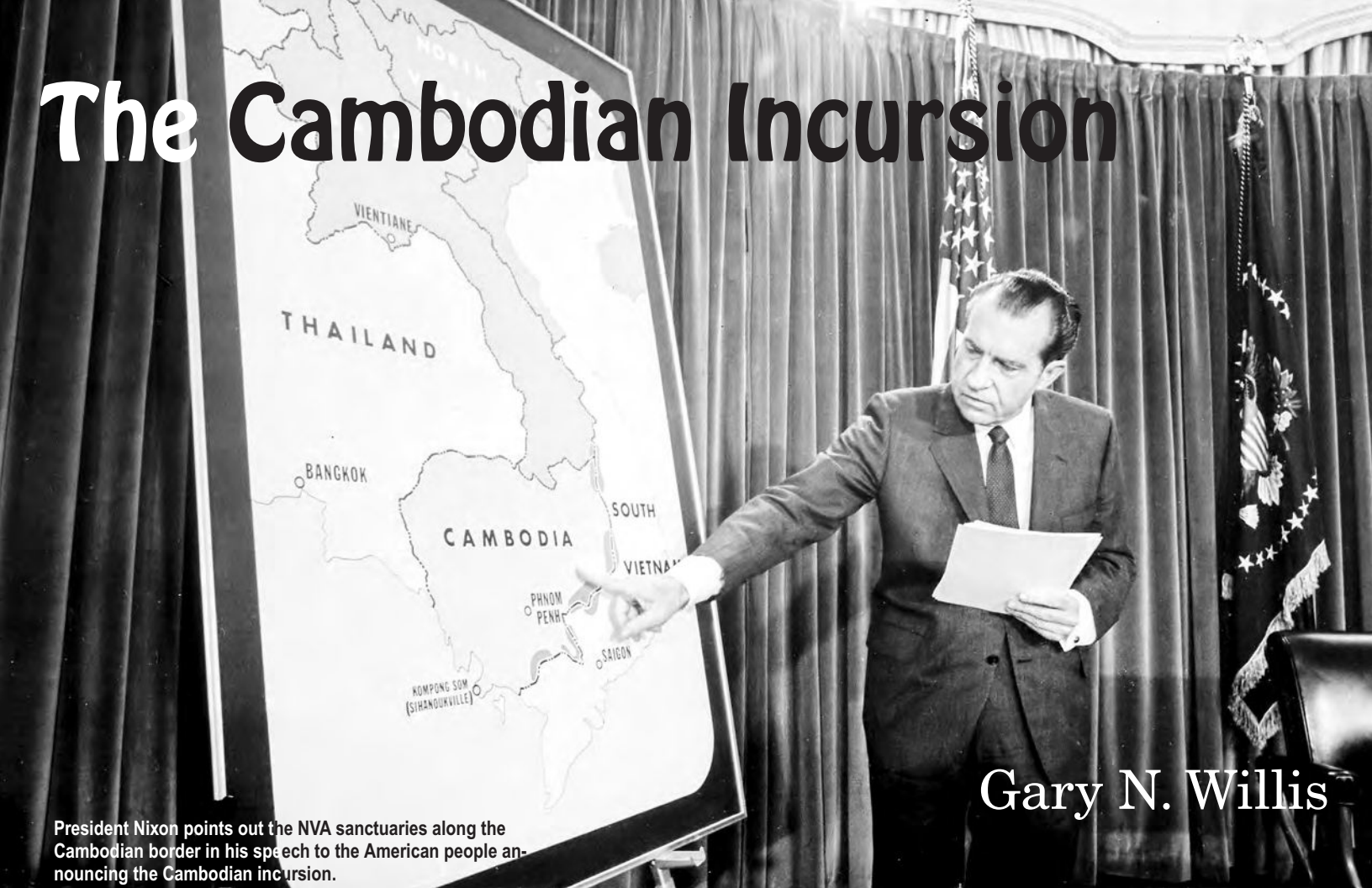

President Nixon points out the NVA sanctuaries along the Cambodian border in his speech to the American people announcing the Cambodian incursion.

Gary N. Willis

**B**efore dawn on 1 May 1970, two Commando Vault C-130B Hercules aircraft from the 463rd Tactical Airlift Wing rumbled down the runway at Cam Ranh Bay Air Base and roared into the night sky. They turned out of traffic and headed west toward the Fishhook of Cambodia.

Two hours earlier, crews from the 14th Aerial Port Squadron used cranes and muscle power to cradle two 15,000-pound bombs onto rolling pallets. They pushed one four-and-a-half-foot diameter, eleven-foot long behemoth nose-first up the tailgate ramp and into the belly of each C-130. On board the aircraft, personnel from the 2nd Detachment, 834th Air Division rigged each Commando Vault bomb, attaching a drogue parachute pack and static lines to its tail. Ordnance specialists installed the ignition system—an extended fuse on a three-foot pipe attached to the nose of each bomb and a tail fuse. The latter triggered simultaneously or served as a backup if the nose fuse failed.<sup>1</sup> With this massive ordnance locked in place, the pilots took off and climbed toward 20,000 feet at 180 knots, heading for a planned drop at 0630 hours. Approaching Dalat, the navigator on each plane contacted a precision radar site known as MSQ-77.<sup>2</sup> The controller at the site gave each a heading direct to target coordinates in the Fishhook. Each navigator relayed the heading to his pilot over the aircraft intercom. Controllers at Dalat fed into their computers the desired aircraft airspeed and altitude, the ordnance ballistics, target location, plus the reported wind direction, wind speed, and atmospheric temperature at the target. From this data, the computer determined when and where to release the bomb to hit within ten meters of the target. The Dalat controllers radioed the required airspeed, altitude, and heading to the navigators and monitored their progress, issuing corrections as needed. As the aircraft cleared the 6,500 foot mountainous terrain of II Corps and approached Song Be, the controllers directed them to slow to 150 knots and descend gradually to 8,000 feet above the rice paddies of III Corps.

## Instant Landing Zones

Six minutes prior to the aircrafts' arrival on target, the controller advised the navigators to prepare to drop. In response, the loadmaster in each plane lowered the rear loading ramp and released one of two cargo locks holding the pallet in place. On the controller's signal thirty seconds prior to the drop, the co-pilot remotely deployed the slotted 24-foot drogue parachute attached to the tail of the bomb. The chute fluttered out of the open ramp and inflated in the slip stream of the aircraft. The navigator repeated over the intercom the controller's final count down: "Five, four, three, two, one, Mark!" At that point, the loadmaster released the second cargo lock. The trailing parachute pulled the skid from the



Commando Vault flight path.

plane. The pilots advanced full throttle as the enormous explosive fell in a silent arc through the sky, stabilized by the drogue parachute. The bomb took twenty-six seconds to reach the ground from 8,000 feet. A brush deflector on the extended fuse penetrated the jungle canopy without triggering the bomb. The C-130 was about a mile away when the bomb disintegrated just above the ground in a blinding flash of light and heat. The force of the blast vaporized surrounding vegetation and created a mushroom cloud that blossomed six thousand feet in the air. The crew in each plane heard the explosion and felt the concussive shock wave. Their task complete, the pilots made a climbing turn toward home.

The first bomb landed very near the Vietnam/Cambodian border at coordinates XU552012.<sup>3</sup> The second exploded on its target several clicks<sup>4</sup> to the west. Each created an instant Landing Zone (LZ) that would soon be assaulted by Vietnamese Airborne troopers.

There were no casualties from the two explosions. Two hours earlier, six B-52 Arc Light missions pounded the southern Fishhook each dropping 81 tons of bombs from a three-ship cell into target areas one click wide by two clicks long.<sup>5</sup> One hour behind the B-52s, 8-inch and 175 millimeter artillery from the 2nd Battalion, 32nd Field Artillery Regiment took over the preinvasion bombardment, firing from bases along the northern border of Tay Ninh Province. The 105 millimeter howitzers of the Vietnamese Airborne Division artillery battalion poured in shells from Katum. By the time the Commando Vault “instant Landing Zone” bombs dropped, the North Vietnamese Army and the Viet Cong had long since taken shelter.<sup>6</sup>

When the artillery bombardment lifted, the 11th Armored Cavalry Regiment (ACR) stormed across the southern border of the Fishhook with the mechanized forces of the 3rd Brigade of the 1st Air Cavalry Division on their left flank. Shortly after the Commando Vault bombs dropped, three battalions of Vietnamese airborne infantry helicopter

*Gary N. Willis graduated from the U.S. Air Force Academy in 1967. After earning an MBA at UCLA, he attended pilot training. He flew an O-1 Bird Dog as a forward air controller supporting the Vietnamese Airborne Division. He then became an instructor pilot and flight commander at Keesler AFB teaching Vietnamese students. He left the service in 1973 and enjoyed a career in the energy industry. Gary and his wife Robin Rankin Willis have two sons and three grandsons. He has published two books about his unit in Vietnam: Red Markers, Close Air Support for the Vietnamese Airborne, 1962-1975; and, Red Markers: The Rest of the Story.*

assaulted into the new landing zones.<sup>7</sup> Later, the Vietnamese 1st Armored Cavalry Regiment rolled across the eastern Fishhook boundary. All were part of Task Force Shoemaker in an operation known as the Cambodian In-cursion. Brigadier General Robert M. Shoemaker, Assistant Division Commander of the 1st Air Cav, created the plan to attack the NVA/VC sanctuary in the Fishhook to destroy the enemy, their basecamps and supply caches. Under his plan, the Vietnamese Airborne landed in the new LZs about six clicks north of the American forces and began ground sweeps. The Americans passed through the Vietnamese positions on Day Two and continued driving to the north.

## Red Marker Crew Chiefs

As the C-130s dropped their payloads, two Forward Air Controllers (FACs) supporting the Vietnamese Airborne Division took off from Quan Loi, east of the Fishhook. These FACs, call sign Red Marker, flew O-1E Bird Dog aircraft. Crew chiefs Sergeant Jim Stokes and Airman 1st Class Jim Hoppe rolled out of their bunks at 0500, grabbed a cup of coffee at the mess hall, and drove a Jeep to the flight line. The night before, they tied down six Bird Dogs in three steel revetments. If a mortar round landed in one revetment, the planes in adjacent enclosures might escape damage. They found their planes safe the next morning. By light from the Jeep headlights, they moved two aircraft out of one revetment. The lightweight Bird Dog was easy to move. Each man pulled a retractable handhold, a steel tube, from the side of the rear fuselage in front of the horizontal stabilizer. They picked the tailwheel off the ground and rolled the O-1 forward on its main gear, maneuvered it into position for startup, and placed wooden chocks in front and behind the main wheels.

Before they bedded down the planes the previous night, Stokes and Hoppe topped off the fuel tanks. With one boot on a wing strut and the other on a footstep below the engine cowling, the crew chiefs opened the fuel filler caps on the top of each wing and pumped in high octane Avgas.<sup>8</sup> This morning, the chiefs rechecked the fuel level in each plane and used the push-valve under the wings to drain the fuel sump on each tank. Overnight, water vapor in the tanks condensed into a small amount of water. The lighter gasoline floated on top, and water collected in the tanks' sump. Draining the sump ensured no water found its way to the engine. As a double check, pilots also drained the sump on their preflight check.

The crew chiefs checked the oil level in the planes, refilling as necessary, and left the engine cowling unlatched so the pilots could take a quick look at the engine before buttoning up. The Bird Dog was pretty easy to maintain. The crew chiefs, however, complained about changing the oil, which they did every fifty hours of flying time. They had to catch the first oil out of the crankcase in a small test tube. Invariably, oil went everywhere besides the tube. However, this messy step was vital. A lab at Bien Hoa Air Base tested the captured oil for minute metal filings that warned of abnormal engine wear and potential failure.





When the pump failed, A1C Jim Hoppe refueled by hand. (Willis Collection.)

Stokes and Hoppe then loaded white phosphorous rockets into the four tubes under each wing, installing red-ribboned safety pins in each tube. The pins held spring-loaded electrical contacts away from the ignitor on the tail of each rocket, preventing inadvertent firing. As the crew chiefs finished their tasks, First Lieutenants Dave Blair, Red Marker 16, and Lanny Mayberry, Red Marker 19, arrived to preflight their planes.

### Red Marker FACs

The previous night, Major Bob Drawbaugh, the Red Marker commander and the Air Liaison Officer for the Vietnamese Airborne, briefed his FACs about the upcoming operation. He issued new maps that covered the Fish-hook region of Cambodia. He gave them a multi-page list of reported enemy antiaircraft sites. The FACs dutifully marked the locations on their maps with a “donut”—a pencil dot with a circle around it. The enemy often built an emplacement for their .51 caliber and larger weapons that looked like a donut from the air. The gunners dug a circular trench a few feet deep, leaving the middle of the circle untouched at ground level. They set the weapon’s tripod on the center section and stood in the circular trench. By moving around the circle, they could aim the gun up and in a 360 degree arc. When the FACs finished marking their maps, the Cambodian border was gray with penciled circles.

First Lieutenant Terry Weaver, Red Marker 17, was the most experienced O-1 FAC in the unit. Logically, he would have flown one of the first cross-border sorties. However, Terry was “short,” with less than a month to complete his tour in Vietnam. Drawbaugh put Weaver in the second group of sorties, a decision likely influenced by the possible air defense they might encounter. Drawbaugh instead scheduled Blair and Mayberry, the next most experienced, to fly the first sorties of the invasion.

The two wore camouflage fatigues with their name, rank, and pilot wings embroidered in black. A cloth tape above their left pocket read US AIR FORCE in black block letters. The uniforms bore the insignia of the Vietnamese



The division patch, a red square with an eagle and a parachute canopy in the middle, was on the left shoulder. The sword of St. Michael patch, a white sword clenched in a yellow-gold winged fist, was on the left breast pocket.



Airborne. The division patch, a red square with an eagle and a parachute canopy in the middle, was on the left shoulder. The sword of St. Michael patch, a white sword clenched in a yellow-gold winged fist, was on the left breast pocket. The FACs also wore the unit’s distinctive red beret. Local tailors added two zippered pockets to the trousers on the outside of the lower legs. An O-1 checklist fit comfortably in one. The other held a pair of flight gloves when the FAC was not flying, and his red beret when he was in the air. The tailors added three small slotted pockets on the left shoulder that held grease pencils and a ball point pen, and a pocket on the right shoulder for a pack of cigarettes and a Zippo lighter.

### FAC Gear

Each FAC slung a CAR-15<sup>9</sup> rifle over his shoulder and wore a web belt carrying a holstered .38 caliber revolver,<sup>10</sup> leather pouches of extra ammo, a sheathed hunting knife, and a canteen of water. In their assigned aircraft they stashed the rifle on the right side of the cockpit. They rested the butt on the cabin floor and secured the barrel to a clasp on the right sidewall. They draped a bandolier of loaded 5.56 mm magazines over the muzzle of the rifle and retrieved their helmets, parachutes, and survival vests from the secure Conex in the revetment.<sup>11</sup> Each put the helmet and parachute on the seat of his plane, donning the vest. It contained a UHF radio, extra batteries, a flashlight, a first aid kit, a map printed on silk, and an emergency ration of high protein bars. The vest also held the airman’s emergency bailout knife. This orange-handled knife had a U-shaped blade with the cutting edge on the inside of the curve. The FACs carried the knife in the vest with the curved blade open. They could use it to cut parachute

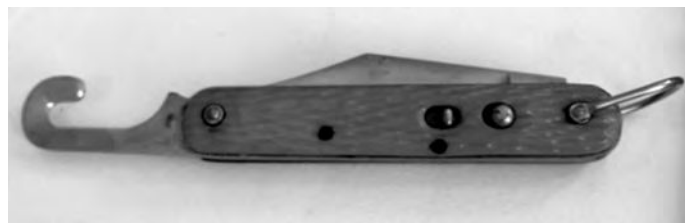



Captain Jim Simpson with FAC Gear. (From his Collection.)

shroud lines if the lines tangled on bailout or hung up in a tree. At least, that was the theory. An emergency bailout from 1,500 feet above the ground with a manually opened parachute did not give a lot of time to deal with fouled shroud lines before hitting the ground. The knife also had a three-inch blade that opened with a push-button ... yes, FACs carried a switchblade. Several feet of para-cord secured the knife to the vest. The cord was long enough that the FAC could reach above his head to the parachute risers and shroud lines. If the FAC dropped the knife while trying to use it, it would not fall to the ground.

Each also had a bulky flak vest. Mayberry and Blair and sat on the vest rather than wearing it, hoping for additional protection from ground fire.

The last thing they loaded into the front cabin was a cloth map case containing topographic maps of the area of operations. These maps were overprinted with the 10,000 meter squares of the UTM Coordinate grid system as well as regular latitude and longitude. Fast moving fighter-bombers, B-52s, and cargo planes had fancy electronic systems and radar for navigation. However, the UTM grid system was the common denominator for locating and communicating positions among all other elements on the battlefield—ground troops, artillery units, helicopters, and FACs.

After completing the preflight inspections, Blair and Mayberry climbed into their Bird Dogs, strapped on the



Sergeant Jim Yeonopolus running the radios at Quan Loi. Lieutenant Mayberry in the background. (Yeonopolus Collection.)

parachute that was sitting in the seat, and buckled the seatbelt and shoulder harness. Meanwhile, the crew chiefs closed and latched the engine cowling. Each FAC removed his red beret, stuck it into the leg pocket of his fatigues, put on his flight gloves and OD Green ballistic helmet with a boom mike. Each plugged the mike cord into his Bird Dog's intercom/radio system. The FACs confirmed all switches were off and placed their hands in sight, gripping the support braces above the glare shield. Once the crew chiefs saw the pilots could not accidentally arm a rocket, Stokes and Hoppe pulled the safety pins from the rocket launchers and handed the red streamers and pins to each FAC through his open cockpit window. The windows in the front cabin were large rectangles, about 24" wide by 18" high, hinged at the top. Both could swing outward and snap to the underside of the wing on each side of the plane. That was the normal configuration when flying in the heat of southern Vietnam. When lowered, the windows were excellent writing surfaces for grease pencil notes.

The crew chiefs stood by with wheeled fire extinguishers as each FAC turned on the battery, adjusted the throttle and mixture levers, shouted, "Switches On, Prop Clear!" and cranked the starter. As the starter whined its typical grinding sound, the propellor moved in fits and starts for a few seconds. The engine fired up in a belch of smoke and an unmuffled roar that settled into a muted pattering. The FACs checked oil pressure, engine RPM, and all instruments and radios.

With their engines running smoothly, Blair and Mayberry in turn contacted Quan Loi Tower for permission to taxi. Hoppe and Stokes pulled the chocks as the FACs signaled they were ready to go. Trading a salute with their crew chiefs, each FAC made a right turn onto the taxiway and headed toward the takeoff end of the runway in the predawn light. As the O-1s pivoted to the taxiway, the chiefs instinctively turned away to avoid facing the red clay grit blown by the propwash. Regardless of their effort, the red grit got in the pores of their skin over their twelve-month tour. It took months back in the States to finally wash out the last vestige. The crew chiefs headed back to the mess hall for a quick breakfast before returning to the flight line to roll two more O-1s out for the next sorties.

On the taxiway, Blair and Mayberry paused to run up the engine to full power while holding the brakes. They



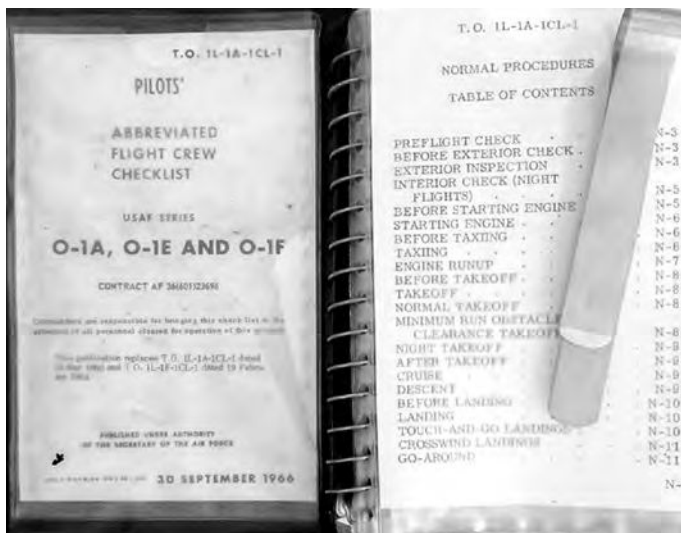

O-1 Bird Dog Checklist

checked that both the right and left magneto were functioning and all engine instruments were normal. With flaps set at 30 degrees, each rolled onto the runway individually, advanced the throttle, held it full open with their left hand, and took off. As they climbed above the ground fog and jungle mist clinging to the treetops, they retracted the flaps, turned west, and headed toward the site of one of the Commando Vault explosions.

The FACs were glad to be off the ground. Even before dawn, the temperature rarely got below eighty degrees in III Corps. With humidity at eighty to ninety percent, they were miserable and sweating profusely. The temperature at 1,500 feet might have been only five degrees cooler, but the wind whistling through the cockpit gave the illusion of comfort. The breeze, however, did only so much good. Sweat soaked the back of their camo blouse and seat of their pants within minutes. Likewise, the crew chiefs were dripping wet by the time the FACs were in the air.

### Red Marker Control/Radio Operators

Once airborne, each FAC called Red Marker Control on a designated VHF radio frequency. Red Marker radio operators Sergeants Walter Stepaniak and Jim Yeonopolus were on duty at Red Marker Control that day. Red Marker O-1s carried six radios, two sets each of VHF, FM, and UHF. The FACs monitored three radios at a time and switched among the sets to transmit as necessary. They remained in contact with Marker Control on one VHF radio. They used an FM radio to communicate with the American advisors in the field with the Airborne troops. They talked to fighter aircraft and controlled airstrikes using the UHF radios. Red Marker Control had those same radios plus a long distance HF set to contact the Direct Air Support Center at Bien Hoa. Center provided the daily operation order for planned airstrikes and when needed scrambled fighters standing alert. Red Marker radios were pallet-mounted in an MRC-108 Jeep powered by the Jeep's electrical system or a generator trailered behind the Jeep.

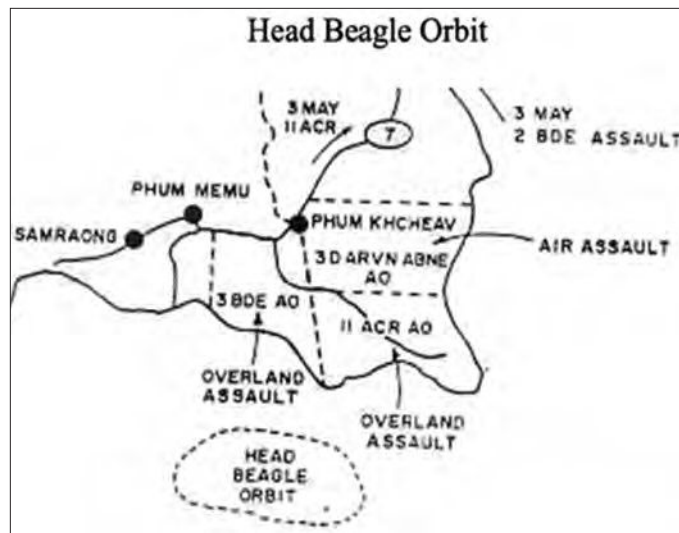

Map from CHECO Report "The Cambodian Incursion".

Major Drawbaugh stationed himself in the Tactical Operations Center at Quan Loi beside the command staff of the 3rd Vietnamese Airborne Brigade and its American advisors in Team 162, known as Red Hats. General Shoemaker designated Quan Loi as headquarters for all Task Force units, which included three supporting FAC detachments.<sup>12</sup> Normally, radio operators dismounted the radios from their Jeeps and installed the pallets in the operations center. Due to space limitations at Quan Loi, they parked the Jeeps outside. After hooking the radios to the portable generator and erecting antennae, they were ready to go.

Red Marker Control kept track of each FAC's position through periodic radio checks. Control also monitored FAC communications with fighter aircraft and the Red Hat advisors on the ground. Experienced radio operators often anticipated the FAC's need for additional airstrikes and alerted the Direct Air Support Center before the FACs requested them.

En route to the Commando Vault sites, Blair and Mayberry squared away their cockpits for action. They climbed to 1,500 feet, set the power at 90 knots cruise speed (104 mph), and trimmed the O-1 for level flight. They leaned the fuel mixture, which conserved gas and prevented fouling the sparkplugs. They would reset the mixture to full rich before maneuvering to control an airstrike. They pulled a grease pencil from their left shoulder pocket and drew a line on the windscreen at the horizon. That line became the horizontal crosshair of the pilot's personal rocket sight. The vertical crosshair was a metal rod about 18 inches long welded to the engine cowling right behind the propeller. This rudimentary rocket site was remarkably accurate.

Each FAC pulled out the map of the Fishhook and identified several landmarks to ensure he was headed in the right direction. They breathed a sigh of relief crossing into Cambodia because there had been no shots fired from anticipated anti-aircraft guns on the border. Their maps showed the Commando Vault locations and coordinates of several airstrikes planned around each LZ perimeter.



Red Marker Bird Dog returns to Quan Loi after controlling airstrikes in the Fishhook.

Each FAC clipped the map in place to his checklist strapped to one knee. He closed one of the cabin windows and wrote in grease pencil the data about each preplanned flight—the scheduled time, mission number, fighter call sign, number and type of aircraft, ordnance, and target coordinates. A typical grease pencil entry looked like this:

*0700/ 5323/ Dog 75/ 2 A-37<sup>13</sup>  
8 Mk-82<sup>14</sup>/ XU522044<sup>15</sup>*

After completing the notes on the window, each FAC located his LZ and surveyed the surrounding terrain.

### The Air Plan

Both FACs received a call on UHF from “Head Beagle,” an airborne traffic controller, a few minutes before the 0700 scheduled arrival of their first set of strike aircraft. The radio exchange with Dave Blair went like this:

*“Red Marker One Six, this is Head Beagle. Over.”*

*“Head Beagle, this is Marker One Six. Go ahead.”*

*“One Six are you ready for your Zero Seven Hundred fighters?”*

*“Affirmative, Head Beagle. Send them on.”*

The Air Liaison Officer for the 1st Air Cavalry Division, Lieutenant Colonel Robert G. “Doc” Daugherty, call sign Rash 01, created the Air Plan for the invasion. Doc planned for the FACs to direct numerous airstrikes supporting the three ground units. He established the Head Beagle and three rendezvous points outside the immediate battle area to control the incoming stream of fighter aircraft. On the way to the pre-assigned rendezvous, each flight of fighters contacted Head Beagle who gave them an orbit altitude. Head Beagle then checked with the assigned FAC to confirm he was ready for the fighters. If so, Head Beagle released the flight with general directions to find their FAC circling low over the jungle. If the FAC could not use the fighters, for example, because of weather in the area, Head Beagle diverted them to another FAC at another target.<sup>16</sup>

### Airstrikes

Head Beagle released the first flights of attack aircraft for both Blair and Mayberry on time. The fighters soon spotted the white-winged Bird Dogs above the green jungle. For the next hour, each FAC directed bombing runs from several sets of fighters into the tree lines surrounding the landing zones. Radio communication began with





South Vietnamese armored personnel carriers in Cambodia, 1970.

fighter lead contacting the FAC on an assigned UHF frequency.

*“Red Marker One Six, this is Dog Seven Five checking in.”*

*“Roger, Dog Seven Five. I am at fifteen hundred feet, south of our target area. Do you have me in sight?”*

*“Roger, Red Marker, have you in sight. Are you ready for my line up?”*

*“Ready to copy, Dog Lead. Go ahead.”*

*“This is Dog Seven Five, mission number five three two three, flight of two A-37s with eight Mk-82 slicks and 7.62 millimeter cannon. We have 20 minutes time on target before bingo fuel.”<sup>17</sup>*

*“Dog Seven Five, copy all. Our target is a tree line on the north side of the landing zone blasted out of the trees. Target elevation is about 100 feet. I want you to run in east to west and break to the south. I will orbit south of the target. Nearest friendlies are six clicks to the south, and that is your safest bailout area. Let’s drop the bombs in pairs, and I will see if there is anything that can use a strafing run. I have encountered no ground fire. Do you copy?”*

*“Roger, Red Marker. Copy all. Run in to the west and break left. Ready for your mark.”*

*“Roger, hold for my mark.”*

Dog flight took up an orbit at about 3,500 feet. The fighters spaced themselves to be on opposite sides of a large oval pattern. They were well outside and above the tight figure-eight flight path Blair flew.

Blair eyed the target out of his left window. He cut the power to idle and pulled back the stick, bringing the O-1 into a 45 degree climb as he reached overhead with his left

hand and armed one of the eight rockets.<sup>18</sup> As the airspeed bled off, he rolled to the left. As the wings approached 90 degrees to the horizon, he kicked in some left rudder and dropped the Bird Dog’s nose below the target. He rolled the wings level and pulled the nose up, centering the target on the vertical rod/front sight.

Blair raised the nose of the plane until the horizontal crosshair—the grease pencil mark on the windscreen reached the target. He eased off a little pressure on the stick to keep the target in the crosshairs and squeezed the trigger on the control stick, firing the rocket with a muffled bang.

When the rocket fired, the O-1 was in a 35 degree dive, airspeed had climbed back to 90 knots, and the aircraft was in perfect trim. While the rocket swooshed toward the target, Blair pulled the nose up and added full throttle, turning into his figure-eight orbit at 1,500 feet. The white phosphorous warhead ignited on impact, and pure white smoke billowed from the trees.

*“Red Marker, this is Dog Lead. I have your mark.”*

*“Dog Lead, roger. Drop in pairs. You are cleared in hot. Hit my smoke.”*

*“Roger that. Dog Lead is in hot.”*

As the Super Tweet made a diving left turn into his bomb run, Blair also turned, keeping him in sight. Dog Lead came screaming past Blair, with the A-37 screeching its distinctive high-pitched whine. Lead pickled<sup>19</sup> two bombs at about 1,500 feet, pulled up sharply to the left, and radioed:

*“Lead is off left.”*

Blair kept his eye on Dog Lead throughout its bomb run. The Bird Dog offered excellent visibility. With plexi-glass windows fore, aft, and overhead in the roof of the cabin, Blair could see the fighter-bomber even when the FAC was in a high-banked turn. If anything went wrong with the fighter—ground fire, a mechanical problem, or anything else—the FAC would see it first.

This run was clean. The 500-pound bombs hit the middle of the roiling white smoke, exploding with two bright yellow-orange flashes followed instantly by two plumes of dark gray smoke. Almost simultaneously, Blair heard the dull double thump of the explosions. He whipped the O-1 around 180 degrees to see Dog Two approaching the turn to its bomb run. Blair kept him in sight, repeating the maneuvers he used to follow Dog Lead.

*“Dog Two is rolling in.”*

*“I’ve got you, Dog Two. Drop in pairs fifty meters short of Lead.”*

*“Roger, fifty meters short.”*

*“Dog Two, you are cleared hot.”*

*"Dog Two is in hot."*

*"Two is off left."*

On a second bombing pass, Blair directed minor adjustments to the aiming point, and Dog flight dropped its last four bombs.

*"Dog Lead, hold high and dry while I take a look."*

*"Roger, Red Marker. Holding high and dry."*

*"Dog Lead, it doesn't look like we have any good targets for a strafing run today. You are released."*

*"Roger, Marker. Standing by for BDA."*<sup>20</sup>

*"Dog Seven Five, negative on BDA right now. We are just kicking ass, not taking names today. We'll send BDA to your squadron in a couple of days."*

*"Red Marker, understood. A pleasure doing business with you. Dog Seven Five Out.—Break. Two, go Channel Five."*

*"click, click"*<sup>21</sup>

*"Red Marker One Six, this is Head Beagle. Are you ready for your Seven Fifteen fighters?"*

*"Head Beagle, roger that. Send them on."*

The smell of cordite mixed with sweat filled the cabin as Blair and Mayberry directed multiple airstrikes around the landing zones for the next hour.

The Cambodian Incursion marked the apex of the Red Markers' involvement in Vietnam. The detachment was almost at maximum strength with a dozen aircraft, six radio Jeeps, and 34 personnel. This sixty-day campaign concentrated more Red Marker assets in a single area of operation and with greater results than any other in unit history. Through the daylight hours during most of May and June 1970, the Red Markers kept two O-1E Bird Dogs and one O-2A Skymaster in the air over the Fishhook. Three radio Jeeps supported the operation, one each at Quan Loi and the Katum and Tonle Cham Special Forces camps. ■

## NOTES

1. "Project CHECO Report – Commando Vault," 12 October 1970.
2. "Project CHECO Report, Combat Skyspot," 9 Aug 1967. The Air Force developed MSQ-77, a narrow beam, X-band radar system by reverse engineering a highly accurate bomb scoring radar the Strategic Air Command employed to train its forces. Strategic Air Command personnel staffed several MSQ-77 sites in South Vietnam.
3. Universal Transverse Mercator (UTM) Coordinates from "Project CHECO Report – Commando Vault," 12 October 1970
4. Klick - A kilometer (1,000 meters), approximately 0.6 mile
5. Arc Light missions were controlled by the same Combat Skyspot radar units that directed the Commando Vault bomb drops. Each B-52 carried 108 Mk-82 500 pound bombs.
6. Referred to sometimes herein as NVA and VC.
7. Engineers with chainsaws to clear debris accompanied the first troopers on the first helicopters.
8. The refueling pit had a small gasoline pump that moved the fuel through a hose from a 3,000-gallon rubber bladder. Air Force C-123s regularly delivered bladders of Avgas and JP-4 jet fuel to the remote airstrip to keep the local helicopters and fixed wing aircraft flying. If the pump failed, the crew chiefs hauled jerry cans to the top of the wing to fill the tanks.
9. Colt Automatic Rifle, variant of the M-16.
10. Standard Air Force issue, Smith and Wesson Model 15, .38 Special with four inch barrel.
11. Conex – an 8' x 8' x 8' corrugated steel shipping container with hinged, lockable doors on one side.
12. Red Marker FACs supported the Vietnamese Airborne, FACs with the call sign "Rash" supported the 1st Air Cav, and "Nile" FACs supported the 11th ACR.
13. "Dog" call sign was used by the 8th Attack Squadron at Bien Hoa Air Base flying Cessna A-37B Dragonfly aircraft nicknamed Super Tweet. The A-37 was a light attack aircraft based on the

Air Force's trainer, the Cessna T-37 Tweet (named for its high pitched sound).

14. Mk-82 is a 500-pound bomb. A high-drag version with retarding fins on the tail was known as "Snake." A "slick" version had no such fins.

15. UTM (Universal Transverse Mercator) target coordinate grid

16. General Shoemaker dissolved the Task Force and Head Beagle control five days into the operation. After that, Red Marker Control handled the fighter aircraft tasked to the Red Markers. Marker Control gave each incoming flight a rendezvous location and orbit altitude before sending the flight to one of several Red Markers who were in the air. Given the heightened activity of the Cambodian operation, two radio operators manned Red Marker Control, double the normal staffing. One handled the radio transmissions, while the other monitored and took notes. They traded each hour. One had a tired voice, the other a tired hand.

17. Bingo Fuel – amount of fuel needed to return to base with an acceptable reserve.

18. Rocket arming switches on the ceiling of the cabin were simple toggles covered by a hinged plastic guard. Once a tube was fired, the FAC left the guard open. He could then easily tell by feel which tubes had been expended and which had live rockets.

19. Pickled – Pilot slang for "Released"

20. After a strike mission, the FAC usually inspected the target and gave the fighters a Bomb Damage Assessment (BDA). On this first day of the invasion, however, the FACs were too busy to provide that report. The Airborne troops would soon sweep the strike area and report the results directly to Red Marker Control. Control matched the location of the BDA to the strike mission and passed it on to the fighter squadron.

21. A wingman sometimes acknowledged Lead by keying his radio transmit button twice. This created two audible sounds – clicks or buzzes. Not an approved radio procedure.



# PIONEERING AIR EVACUATION IN WORLD WAR II



AAF School of Air Evacuation transport aircraft flying over the valley of the Ohio River used to condition flight nurses and medical technicians to being in flight. (Leora Stroup Collection, AMEDD Center of History and Heritage Archives, Fort Sam Houston, Texas.)

## Grant T. Harward

On June 18, 1942, the War Department charged the Army Air Forces (AAF) with the “development and operation of air evacuation,” which became the responsibility of Air Surgeon Brigadier General David N. W. Grant.<sup>1</sup> He had pushed for increased control over air evacuation since before his current position existed when he became Chief Flight Surgeon of the Air Corps in 1939. The Surgeon General remained responsible for evacuation and hospitalization for the Army, but it had become clear that air evacuation should be pioneered by airmen not soldiers. Grant believed air evacuation depended on recruiting women trained to provide in-flight medical care to patients. This was met with skepticism. One interwar Surgeon General had concluded, “If commercial aviation companies require special nurses in any way, which at present I can’t visualize, this is a matter that has nothing to do with the Medical Department of the Army.”<sup>2</sup> Grant’s efforts soon bore fruit. “Your graduation in the first class of Nurses from the first organized course in air evacuation marks the beginning of a new chapter in the history of nursing,” he proclaimed just eight months later on February 18, 1943. “Air Evacuation of the sick and wounded is already an accomplished fact requiring only trained personnel for rapid and extensive expansion.”<sup>3</sup> He then pinned his flight surgeon insignia on the flight nurse honor graduate, and declared flight nurses would receive the same with an N superimposed on it.

This article argues air evacuation of the sick and wounded is a critical function of the Air Force that is often forgotten because it is overshadowed by strategic bombing, close air support, and other missions. The AAF’s pioneering efforts in air evacuation during World War II initiated a revolution in the realm of military medicine that is now taken for granted. The AAF evacuated 1.2 million sick or wounded patients by air in all theaters with less than five hundred dying in flight. General Dwight D. Eisenhower, during a press conference on June 18, 1945, credited air evacuation, together with sulfa drugs, penicillin, blood plasma, and whole blood, with reducing the fatality rate of casualties. “We evacuated almost everyone from our forward hospitals by air, and it has unquestionably saved hundreds of lives—thousands of lives.”<sup>4</sup> Nonetheless, the history of air evacuation during World War II remains little celebrated.

This article has two goals. The first is to review the rapid development of air evacuation by the AAF during World War II from ideas on paper to operational squadrons. The second is to tell the story of one of the squadrons conducting air evacuation operations in the Mediterranean Theater of Operations (MTO). It would take a lot more words to tell the complete story of all the squadrons involved in air evacuation during World War II, so the author decided to write about one with a particularly interesting wartime history. This squadron faced the same basic challenge as all the others, so its experiences are generally representative of the rest and show why certain changes were made to the air evacuation program over the course of the conflict. In addition to these two aims, this article highlights the extra challenges faced by

flight nurses. The all-female Nurse Corps was one of the few ways women could lead as officers during World War II. These pioneers of air evacuation not only braved bad weather, accidents, and sometimes enemy fire, but also convinced often skeptical commanders of the value of the service that they provided.

## Origins of Air Evacuation

As soon as airplanes began to fly, the Army saw the potential of air evacuation in saving lives. The first transport of patients by aircraft by the Army was in 1910. During World War I, the Army Air Service air evacuated a handful of patients and experimented with air ambulances in 1918. Flight surgeons appeared with the primary duty of evaluating aircrews' fitness. The Army's first specially designed air ambulance flew in 1920.<sup>5</sup> Thereafter, air evacuation stagnated until after maneuvers in 1931. Then, in 1935, citing successes in air evacuation by the French Air Force in North Africa and the Marine Corps in Nicaragua, the Army Air Corps recommended procuring two types of aircraft for medical use. First, a single-engine air ambulance capable of squeezing in a pilot, a flight surgeon, and two patients to operate from small airfields close to the front. Second, a two-engine air ambulance able of carrying a pilot, a flight surgeon, and a half dozen patients plus a water tank, toilet facilities, and a medical supply cabinet. Unfortunately, the Army lacked funds and rejected the idea for specialized medical transport aircraft. Lieutenant Colonel Malcom C. Grow, Chief Flight Surgeon from 1934 to 1939, reluctantly went along with plans to use regular transport aircraft for air evacuation in case of hostilities.<sup>6</sup>

Only once war broke out in Europe on September 1, 1939 did the Army start to build up its air evacuation capability. The Surgeon General began designing a Medical Transport Group on July 11, 1940.<sup>7</sup> The Army considered requisitioning civilian transport aircraft to equip it.<sup>8</sup> On November 19, 1941, the Medical Air Ambulance Squadron (MAAS) was authorized with 45 officers and 218 enlisted men organized into a headquarters section, one "light" air

ambulance section, and two "heavy" air ambulance sections. The Medical Transport Group was supposed to have a headquarters squadron, one light MAAS with eighteen one-engine transports, and two heavy MAASs with eighteen two-engine transports.<sup>9</sup> The light MAAS would whisk casualties from the battlefield to the rear for treatment. The heavy MAASs would then lift patients from hospitals near the front to hospitals farther in the rear in theater or even in the Zone of Interior (the United States). The Medical Transport Group would be attached to the theater headquarters overseas. The Japanese attack on Pearl Harbor occurred less than a month later on December 7, catching the Army without a functioning air evacuation program.

The Army turned to stop gap solutions. In January 1942, the Army evacuated injured or sick workers constructing part of the ALCAN Route in Alaska by air. The airplanes lacked trained medical personnel to provide in-flight care to patients because there was no other option. This emphasized the need for the MAASs. The Marshall reorganization on March 9 created the AAF, Army Ground Forces (AGF), and Army Service Forces (ASF). This gave the AAF more independence to achieve its goals, including creating the Office of the Air Surgeon, which gave General Grant authority over air evacuation. He had help from Major Richard L. Meiling who had taken note of how the Germans employed airplanes as air ambulances during the Spanish Civil War between 1936 and 1939 while he was a medical student in Nazi Germany. He became the sole "Air Evacuation Officer" in the Office of the Air Surgeon.<sup>10</sup> In April 1942, AAF aircraft evacuated 1,900 sick and wounded British and Chinese troops from Burma to India in ten days. On May 25, the 38th MAAS was activated at Fort Benning near Columbus, Georgia at a reduced strength of 2 officers and 138 enlisted men for testing. Around this time, the AAF began air evacuating sick and wounded U.S. and Australian troops from New Guinea to Australia, a total of 1,300 patients over 70 days.<sup>11</sup> Each of these successful ad-hoc air evacuation operations used whatever transport aircraft were available. Consequently, AAF leaders became convinced that the 38th MAAS not only did not need specialized medical transport aircraft but also that it did not need any organic airplanes.

General Grant changed tack even as he tried to salvage part of his dream for dedicated medical transport aircraft. The plans for the Medical Transport Group were thrown out and new ones drawn up for the Airplane Evacuation Group (Medical). This formation was supposed to have 69 officers (20 from the AAF and 49 from the Medical Department), 78 nurses, and 458 enlisted men organized into a headquarters squadron, one light MAAS, and three heavy MAASs. Each heavy MAAS would consist of just medical personnel (for the first time including nurses), so it would have to rely on transport squadrons to move patients. The light MAAS would still have twenty small aircraft requiring 20 pilots, however.<sup>12</sup> On July 24, he obtained approval to move the 38th MAAS to Bowman Field outside Louisville, Kentucky, and use it as the framework around which to build the Airplane Evacuation Group (Medical).

*Grant T. Harward is a native of southern California. He completed his B.A. in history at Brigham Young University in 2009, his M.Sc. in the Second World War in Europe at the University of Edinburgh in 2010, and his Ph.D. in history at Texas A&M University in 2018. He is a former Auschwitz Jewish Center fellow, a former Fulbright scholar to Romania, and a former Mandel Center fellow at the U.S. Holocaust Memorial Museum. He was a historian for the U.S. Army Medical Department Center of History and Heritage at Fort Sam Houston ("Home of the Combat Medic") in San Antonio from 2018 to 2021. He now works as a historian for the U.S. Army Center of Military History. Dr. Harward has written numerous articles about the history of U.S. Army medicine and the Romanian Army during World War II. Cornell University Press recently published his book, Romania's Holy War: Soldiers, Motivation, and the Holocaust (2021).*





Flight nurse students practice loading litters on a mockup plane at AAF School of Air Evacuation, Bowman Field, Kentucky. (Army Nurse Corps Photographs Collection, AMEDD Center of History and Heritage Archives, Fort Sam Houston, Texas.)

Yet AAF planners balked at assigning even small aircraft as organic assets to the light MAAS. Major General Muir S. Fairchild, the AAF Director of Military Requirements, argued such “puddle jumper squadrons” were a pointless waste of airplanes. If enemy fire prevented ground ambulances from evacuating casualties, he saw no reason why air ambulances would have more success. Furthermore, Fairchild did not want a medical officer commanding AAF officers, which was against regulations.<sup>13</sup> On October 1, the 38th MAAS became the 507th Air Evacuation Squadron (AES) (Heavy). Six days later, the 349th Air Evacuation Group, under Lieutenant Colonel Ralph T. Stevenson, consisting of a headquarters squadron with two flight surgeons, six flight nurses, and fifteen enlisted men, was activated. On November 11, the 620th and 621st AESs (Heavy) and the 622d AES (Light) joined the 349th Air Evacuation Group.<sup>14</sup> The next day, Fairchild took his concerns to Lieutenant General Henry Arnold, the commander of the AAF, who decided against Grant.

The Office of the Air Surgeon scrambled to reorganize the AESs. Major Meiling helped General Grant design the Medical Air Evacuation Transport Squadron (MAETS), which was tentatively accepted on November 30. On the same day, Grant issued an emergency call for nurses and airline hostesses to volunteer for the Nurse Corps to become flight nurses. Soon after, the War Department directed that the 349th Air Evacuation Group would not deploy overseas but stay at Bowman Field to train flight surgeons, flight nurses, and medical technicians.<sup>15</sup> Yet the demand for air evacuation meant that the first MAETS personnel received limited training specific to their new duties. On December 11, the 620th and 621st AESs (Heavy) became the 801st and 802d MAETSs, and the 803d, 804th, 805th, and 806th MAETSs were activated. The 802d MAETS left for the MTO on Christmas Day and

the 801st MAETS departed for the Pacific Theater of Operations (PTO) four days later.<sup>16</sup> The 349th Air Evacuation Group began courses for MAETS personnel in January 1943.<sup>17</sup> On January 30, the superfluous 622d AES (Light) was disbanded. The final shape of the MAETS was approved on February 15, three days before the graduation of the first class of flight nurses. The headquarters section had a chief flight surgeon, a chief nurse, a Medical Administration Corps officer, and twenty-nine non-medical enlisted men for “housekeeping” (cooking, recordkeeping, etc.). Then there were four evacuation flights, each with six flight nurses and six medical technicians under a flight surgeon. Every evacuation flight divided into six flight teams of flight nurses and medical technicians serving in pairs on each transport aircraft.<sup>18</sup> This arrangement proved functional enough over the coming years.

General Grant had pushed for flight nurses for a few reasons. First, he was not going to obtain more than a bare minimum of flight surgeons for air evacuation, but he wanted more than hastily trained medical technicians. In-flight care presented extra challenges due to the effects of altitude on the human body, so trained and experienced nurses were better suited to provide the necessary treatments during air evacuation. Using nurses allowed Grant to tap into a vast pool of womanpower at a time when AGF, AAF, and ASF all competed for manpower. Second, it was widely believed that the presence of a calm female flight nurse would allay fear of flying among the male patients.<sup>19</sup> Third, young, attractive women in uniform were useful in helping the AAF to “sell” air evacuation to the rest of the Army and the wider public. Colonel Ehrling Bergquist, the IX Troop Carrier Command Surgeon in the ETO, later argued, “The use of nurses was probably the wisest thing that air evacuation ever had. The young ladies were highly enthusiastic, and they sold the air evacuation program.”<sup>20</sup> Whatever the reasons, many women jumped at the chance to volunteer for the exciting and dangerous job of a flight nurse.

### Air Evacuation Training

With the wider context of the AAF air evacuation program established, it is time to focus more on the story of one of the squadrons and follow it through its training. The 807th MAETS was activated at Bowman Field on May 1 under the command of Captain William P. McKnight, but it took over two months for the squadron to reach its full complement of six flight surgeons, twenty-five flight nurses, and sixty-one enlisted men.<sup>21</sup> It had become apparent that the 349th Air Evacuation Group needed to be reorganized because it was not a typical operational training unit. Consequently, on June 23, it became the AAF School of Air Evacuation.<sup>22</sup> By then, training for flight surgeons, flight nurses, and medical technicians was routine.

Each group in the 807th MAETS first attended separate courses for individual training. In addition to earlier civilian medical training, Captain McKnight and the other four flight surgeons had attended the School of Aviation Medicine at Randolph Field in San Antonio, Texas. Upon

their arrival at Bowman Field, they attended a three-week orientation course in command and administration of a MAETS for Medical Corps officers. Ironically, the need to fulfill such duties often interrupted McKnight's and the other flight surgeons' training. They did not require much specialized medical training because the primary medical duty of MAETS flight surgeons was determining if patients were healthy enough for evacuation by air. Soon afterward, the course was shortened by a week for future Medical Corps officers. It is unclear which of the schools for medical administration that the squadron's sole Medical Administration Corps officer trained at before coming to Bowman Field. He did not receive any additional aeromedical training only on-the-job training in the particularities of administering and supplying a MAETS.<sup>23</sup> McKnight was quiet but effective and respected as the 807th MAETS's commanding officer.<sup>24</sup>

The flagship course of the AAF School of Air Evacuation was the one for flight nurses. The female volunteers had to be between 62 to 72 inches, 105 to 135 pounds, and 21 to 36 years. Moreover, they had to pass the standard physical examination for flying. Physical fitness was a priority because it was tiring to work at 5,000-10,000 feet in unpressurized airplanes.<sup>25</sup> First Lieutenant Grace Stakeman, the chief flight nurse, and twenty-four second lieutenants arrived at Bowman Field with no military training. Nurse Corps officers held relative rank, meaning they could command enlisted men but lacked the same authority and status as other medical officers. They were paid half that of male officers, however, flight nurses earned \$60 more a month than other nurses.<sup>26</sup> While most of these women were trained, experienced nurses, some were airline hostesses with only basic instruction in first aid, and both groups knew little about in-flight care. Consequently, the flight nurse course had been expanded from four to six weeks. It covered basic subjects like anatomy, ward management, operating-room technique, nursing, first-aid hygiene, and sanitation. However, it focused on aeromedical physiology, aeromedical therapy, handling neuro-psychiatric patients, enemy plane identification, procedures for emergencies, chemical warfare, and even religious procedures. The flight nurses were shown what happens to a body deprived of oxygen at 10,000-15,000 feet by a volunteer entering a low-pressure chamber. They were also flown over the Ohio River. The flight nurse course included instruction in being an officer and physical training including daily exercises, long marches, dodging flour bombs (to simulate air attacks), and navigating obstacle courses.<sup>27</sup> Additionally, flight nurses helped train incoming medical technicians at local hospitals in nursing. The unit history commented that, "This hospital duty served as a refresher course for the nurses themselves in bedside procedures."<sup>28</sup> The flight nurse course was extended to eight weeks later that year because there was so much to cover.

The medical technician course prepared enlisted men. The 807th MAETS was authorized one master sergeant, one staff sergeant, twenty-four technicians third grade, one sergeant, two technicians fourth grade, nine corporals, five technicians fifth grade, nine privates first class, and nine



First graduating class of flight nurses conducts drills at Bowman Field in early 1943. (Leora Stroup Collection, AMEDD Center of History and Heritage Archives, Fort Sam Houston, Texas.)

privates. The squadron's enlisted men all completed at least three weeks of basic training before arriving at Bowman Field. The 807th MAETS's non-medical enlisted men also attended five weeks of specialized training at various Army schools.<sup>29</sup> However, the squadron's twenty-four technicians third grade attended a five-week course at Bowman Field. Flight nurses first instructed medical technicians at three civilian hospitals in nearby Louisville for two weeks in nursing, intravenous techniques, catheterization, oxygen administration, and other medical practices. Then they attended a two-week class in emergency medicine, converting transport airplanes for use as air ambulances, loading patients, and using equipment. Finally, a week of practical training consisting of flights, field maneuvers, and study of psychotic patients followed.<sup>30</sup> There were even speed competitions to see who could load and unload patients the quickest.<sup>31</sup> The medical technicians were often referred to as "medics."

Finally, the 807th MAETS went through the AAF School of Air Evacuation's flight-training course. This was unit training designed to supplement all the other training and teach flight surgeons, flight nurses, medical technicians, and other enlisted men to work together as a squadron. All members of the 807th MAETS had to meet the preparation for overseas movement requirements, which included survival training that culminated in an overnight bivouac in the Kentucky countryside. The length of this training varied greatly from squadron to squadron.<sup>32</sup> The personnel in the 807th MAETS completed their training and received leave in July to visit their families one last time before shipping overseas. On August 11, the squadron assembled at the railway station in Louisville and left for the east coast.

The MAETSs, especially the flight nurses, still had a lot to prove to the rest of the Army. Even other nurses in the Nurse Corps did not respect flight nurses. Many nurses believed flight nurses were upstarts with inferior training. They may also have been jealous of all of the extra atten-



tion lavished on the women in the MAETSs and their extra pay. Nurses' hostility focused on flight nurses' special insignia. Often flight nurses arriving in theater or who wanted to work in an AGF hospital while waiting to begin air evacuation operations were forced to remove their flight nurse insignia by other nurses during the six months before the War Department authorized it.<sup>33</sup> By the time the 807th MAETS departed Bowman Field, such harassment had largely ceased, but many AGF commanders remained skeptical about air evacuation.

## Deployment Overseas

The 807th MAETS arrived at Camp Kilmer in New Jersey for staging. The squadron set to work updating records and packing equipment, and received new equipment. Flight nurses got olive drab clothing, raincoats, and striped seersucker uniforms for duty wear. The squadron also was issued new gas masks that had to be tested to ensure that they fit properly. After the 807th MAETS passed inspection, some officers and enlisted men received day passes to New York City. The women were held back to be filmed drilling in their new clothing, however. "This was done by the signal officers who were to use the finished movie to recruit women into the Armed Services," recorded the unit history.<sup>34</sup> Despite a nurse shortage and the danger of air evacuation, the AAF had little trouble recruiting flight nurses.<sup>35</sup> On August 20, the 807th MAETS boarded a ship and crossed the Atlantic Ocean without incident, but after passing the Strait of Gibraltar experienced an air raid and a submarine alarm. "There was much talk about the possibility of being introduced to war in a very real way," noted the unit history.<sup>36</sup> On September 4, the ship arrived at Bizerte in Tunisia.

The port was heavily damaged from previous fighting and recent air raids. While the Allies had secured North Africa and Sicily and had just landed in Italy, enemy aircraft could still fly the relatively short distance across the Mediterranean Sea to strike targets in the Allied rear. German aircraft remained a threat to MAETSs in the MTO. The 807th MAETS was the first to disembark at Bizerte. "Here the nurses got their first taste of what it was like to be so few women among so many men as the very sun-tanned veterans on the shore whistled and gaped," wrote First Lieutenant Stakeman. "It was a strange experience for the nurses to be 25 women amidst 10,000 troops, a third of whom were colored."<sup>37</sup> The squadron stayed for six days during which time the flight nurses and medical technicians kept busy with rotations in the "sick tent" in between taking cover during sporadic enemy air raids until their luggage and equipment arrived from the port. Then the 807th MAETS relocated to Foch Field a few hours away.<sup>38</sup>

The flight surgeons received on-the-job training before the squadron became operational. The XXII Troop Carrier Command (Provisional) Surgeon and the 802d MAETS commander welcomed the 807th MAETS to Foch Field who informed them that the squadron would initially operate under supervision. On September 13, 807th flight surgeons were dispersed to 802d air evacuation stations in Sicily,



Flight nurses training on a pistol range at Bowman Field. (Army Nurse Corps Photographs Collection, AMEDD Center of History and Heritage Archives, Fort Sam Houston, Texas.)

Tunisia, and Algeria to learn how to run air evacuation stations. The flight nurses, medical technicians, and other enlisted men stayed behind while the Medical Administrative Corps officer searched for supplies and transportation. After a month, he located 135 of 155 boxcars of equipment and supplies, the rest had been lost, stolen, or ransacked en route. Although promised new jeeps, trucks, and ambulances, the 807th MAETS only obtained "cast-off" vehicles.<sup>39</sup> On October 6, the squadron moved by air to Catania, Sicily, and made its first operational flight air evacuating patients from Corsica to Algeria. The 807th MAETS was reassigned to the 52d Troop Carrier Wing (Provisional) under the 314th Troop Carrier Group.

By now, flight surgeons knew that any patient transportable by ambulance could be evacuated by air ambulance, so only classified patients by priority. Priority I needed expert nurse care, Priority II required only minor nursing while in flight, and Priority III did not need any special attention.<sup>40</sup> Flight nurses and medical technicians soon became accustomed to flying on different airplanes with unfamiliar aircrews.<sup>41</sup> In October, the squadron had evacuated 1,651 patients primarily from air evacuation stations at Grottaglie and Bari, ports respectively on the southern and eastern coasts of the Italian Peninsula.<sup>42</sup>

## Crash Landing

A stroke of bad luck hit the 807th MAETS just as the squadron was getting into its stride. On November 8, thirteen flight nurses and twelve medical technicians, plus an enlisted man from the 802d MAETS, boarded a C-53 in Catania bound for Bari. This transport aircraft was a variant of the C-47. The four-man flight crew had never flown together and ran into bad weather. The pilot tried to fly around the clouds and follow the Italian coast but the weather only deteriorated. The flight crew could not convince the Bari airport to turn on a radio beacon because they lacked the proper password, lost radio communica-



**"Flying Nurses" to care for American wounded transported from advanced airfields to hospitals in Australia, have just arrived in Southwest Pacific. Sergeants of a medical air evacuation squadron demonstrating methods of loading patients into a plane to nurses of same organization. 804th Med Air Evac Tran Sq, Archer Field, Brisbane, Q'land, Australia, July 31, 1943. (Army Nurse Corps Photographs Collection, AMEDD Center of History and Heritage Archives, Fort Sam Houston, Texas.)**

tion, had trouble with their compass, and became utterly lost and confused. They spotted what appeared to be an abandoned German airfield through a gap in the clouds and tried to land, but then enemy anti-aircraft guns opened fire and fighters scrambled. The American airplane escaped into the clouds. After five hours, the flight crew had to land because fuel was running out. They spotted a dry lakebed and crash-landed.<sup>43</sup> A group of locals approached and one who spoke English informed the bewildered Americans that they were not in Italy but in Albania.

The airmen, flight nurses, and medical technicians were trapped behind enemy lines. The situation in Albania was dangerous and complex. Fascist Italy had occupied the country from April 1939 to September 1943 when Nazi Germany took control after the Italian armistice with the Allies. The *Lëvizja Nacional-Çlirimtare* (LNÇ), or National Liberation Movement, was an umbrella organization of Albanian resistance groups that continued to fight the occupiers. The British Special Operations Executive (SOE), which was tasked with espionage, sabotage, and reconnaissance in occupied Europe, had agents in Albania to support the LNÇ. Bands of Italian troops also wandered the countryside trying to avoid capture by their erstwhile German allies. The *Balli Kombëtar* (BK), or National Front, was an anticommunist militia that had worked for the Italians and now for the Germans. Albania was one of the poorest and most underdeveloped countries in Europe with only twenty-six miles of paved road and limited electricity or indoor plumbing. Over three quarters of the country is rugged mountains crisscrossed by large, difficult to navigate rivers.<sup>44</sup> German troops controlled the main cities and roads, but maintained a limited presence in the countryside.

The Albanians who met the Americans were willing to protect them from the Germans. Fortunately, many were

members of the LNÇ, so they could put the Americans in touch with the British SOE. The locals' willingness to aid the crash survivors went beyond politics or having a mutual enemy. Most Albanians still followed *besa* ("faith" or "oath") a medieval code of honor that including helping those in need.<sup>45</sup> Nevertheless, the LNÇ also had its own agenda and used the Americans as a propaganda tool for recruitment and leverage to obtain more support. After hiding for three days, on November 12, the Albanians took the Americans into the town of Berat where they were greeted by cheering locals as LNÇ leaders gave speeches saying the Americans were the advanced part of an Allied "invasion force." Over the next days, the Americans endured more speeches at the town hall where the Albanians repeatedly asked for the Allies to send more aid. All the publicity attracted unwanted attention. On November 15, German forces attacked the town. The Americans became separated. Three flight nurses remained hidden in a basement of the town. The BK commander who became responsible for Berat was convinced that it was in his interest to protect the Americans and conceal their presence from the Germans. Meanwhile, the remaining twenty-seven Americans regrouped and went on the run led by their LNÇ guides through treacherous mountains in increasingly cold weather.<sup>46</sup> On November 19, back in Sicily, the 807th MAETS officially declared its personnel as missing, and then dropped them from its rolls two days later in order to request replacements.

The squadron had to find a way to carry out its mission with half its personnel missing. The air evacuation station at Bari had "become unreasonably busy" while the one at Grottaglie had been closed and another opened at Foggia. It would take time before replacements arrived. Meanwhile, two flight nurses were hospitalized with jaundice, exacerbating the already difficult personnel situation facing the 807th MAETS. The squadron turned to the headquarters section, finding volunteers from among "some of the better qualified" non-medical enlisted men. After an expedited training course, four enlisted men qualified as medical technicians. Furthermore, flight nurses and medical technicians were assigned singly to care for an airplane load of patients each. A flight nurse for litter patients or a medical technician for sitting patients. Despite its personnel crisis, the 807th MAETS still managed to evacuate 4,345 patients from Sicily and Italy to North Africa during November.<sup>47</sup> Most of these sick and wounded were from the British Eighth Army, which presented additional problems. First, "selling" air evacuation. "It was at first somewhat difficult to convince the British of the necessity of placing trained medical attendants aboard aircraft carrying patients, but after some experience with a squadron of our type, they became convinced of the advantages of the attendants," recorded the unit history.<sup>48</sup> Second, liaising with British hospitals to obtain accurate figures of patients, so flight surgeons had the right number of flight nurses and medical technicians in the right place at the right time. Third, British (and later French) litters caused problems because they did not fit properly in ambulances and were harder to load into airplanes.<sup>49</sup>



Yet the 807th MAETS's biggest challenge was finding American transport aircraft. The squadron had moved from the 52d Troop Carrier Wing (Provisional) to the 51st Troop Carrier Wing and had not yet developed a smooth operating relationship. Flight surgeons spent most of their waking hours acting as liaisons with transport squadrons to line up transport aircraft to pick up casualties. These Medical Corps officers performed so few medical duties that one post-war report argued that Medical Administrative Corps officers might have been better suited.<sup>50</sup> The unit history complained, "Frequently, patients would be available for evacuation when there were no returning planes. Also, not infrequently, planes would have to return to Sicily empty because of the unavailability of patients at that particular time."<sup>51</sup> Poor communication between the squadron and transport squadrons often created pile-ups of medical personnel and patients. Bad weather could cancel air evacuation even when medical personnel, patients, and transport aircraft all showed up. Consequently, air evacuation holding units capable of treating 200 to 700 patients located within two to five miles of an airfield became a necessity. Whenever transport aircraft failed to appear or bad weather canceled flights, patients could be taken to wait close by.<sup>52</sup> MAETSs adopted this practice in all theaters.

### Equipment Troubles

The 807th MAETS became dissatisfied with some of its equipment. The Office of the Air Surgeon had approved an air ambulance medical chest designed for trips lasting six to nine hours when General Grant and his planners envisioned long flights between theaters and from theater to Zone of Interior. It was fine for air evacuation in the PTO due to the great distances involved. Nonetheless, the standard air ambulance chest was too big and too heavy for the short, in-theater trips lasting at most a few hours that became the norm in the MTO (and later in the ETO). The 807th MAETS created a simpler, lighter air ambulance medical chest that was more convenient for its situation.<sup>53</sup> A similar solution was adopted by other MAETSs.

The 807th MAETS also faced equipment shortages. Each MAETS required litters (plus supports) and blankets for up to eighteen patients for each transport aircraft. All this equipment weighed an estimated 548 pounds, which was a significant portion of the C-47's normal 5,000-pound payload, so it was too heavy to keep on board every transport aircraft until it was needed. Therefore, flight surgeons tried to create pools of this equipment at forward airfields. Litters and blankets had a low priority for transportation squadrons, however, and MAETS discovered it was difficult to move this medical equipment from rear to forward air stations. Consequently, despite their best efforts, litters and blankets were often in short supply.<sup>54</sup>

The Office of the Air Surgeon developed more specialty equipment for air evacuation over the course of the conflict. This included continuous-flow oxygen units for in-flight oxygen therapy (transport aircraft did not fly high enough for normal oxygen systems to function); air mattresses and

sleeping bags for fatigued patients on long flights; portable heaters and air conditioners to keep transport aircraft heated or cooled depending on season or climate; and fork-lifts to help load patients in litters.<sup>55</sup>

### Gas Casualties

The 807th MAETS was the only such unit to provide care to gas casualties. On December 2, a German air raid against the port at Bari hit many ships including a transport carrying a secret cargo of mustard gas bombs brought in case the desperate enemy resorted to chemical warfare. A massive explosion rattled the offices being used by the squadron's personnel at the airport miles away and subsequent smaller blasts prompted them to evacuate to an air evacuation holding unit outside the city. An estimated one thousand American and British servicemen, and many more uncounted Italian civilians, were killed by explosions in Bari. Most of the mustard gas went into the water and floated on the surface, but some was vaporized and mingled with smoke to create a kind of cloud. Mustard gas killed few, but caused chemical burns and other injuries.<sup>56</sup> As no one knew that the ship contained mustard gas bombs, many sailors and merchant mariners fished from the water remained in clothing soaked in the hazardous chemicals for hours. Only in the morning after the 807th personnel had returned to continue their work in Bari under the smoke of burning ships did terrifying rumors begin to spread that a ship with mustard bombs was about to blow up. With the wind shifting, the squadron evacuated its personnel from Bari to Catania. Once it was safe, the 807th MAETS sent the evacuation flight back and air evacuated many of the chemical burn patients from the mainland to hospitals in Sicily.<sup>57</sup>

### Albanian Escape

Coincidentally, the same night of the disastrous attack, the U.S. Office of Strategic Services (OSS) in Bari sent an agent across the Adriatic Sea to help rescue the missing 807th personnel. The OSS had the same mission as the British SOE to conduct various operations behind enemy lines. The group of American airmen, flight nurses, and medical technicians had finally met up with British SOE agents. Soon afterward, the 807th MAETS learned its missing comrades were still alive. "Everyone prayed for a grand reunion at Xmas which did not materialize," noted the unit history.<sup>58</sup> For some reason the Albanian LNC guides had taken the Americans farther east toward Greece away from the coast.<sup>59</sup> Now lead by British SOE agents, they set off west for the coast, but had to take a meandering route to avoid German soldiers and Albanian BK militiamen continuing their epic trek across Albania.

After weeks of cross-country hiking in winter weather, shoes fell apart, clothing became filthy, and bodies weakened. The British SOE agents decided to try to use an abandoned Italian airfield to evacuate the exhausted American survivors by air, but German troops appeared nearby just before the appointed time on December 29. The



The rescued flight nurses, medics, and flight crew pull into Bari, Italy, ending their 600-mile journey from behind enemy lines during WWII. The medical team's aircraft crash-landed in November 1943 in Nazi-occupied Albania. (Air Force photo.)

British SOE agents decided the risk was too great to chance an attempt at an air evacuation. The British and Americans were stunned to see that the Twelfth Air Force had dispatched not just two C-47 transport aircraft, but also thirty-one P-38 fighter-bombers and one Wellington medium bomber. Perhaps such a powerful air umbrella could have kept back the enemy, but none of the American survivors was in position for a last-minute change of mind because of the British SOE agents' earlier decision.<sup>60</sup> The dejected group skirted around the enemy troops and resumed its long march.

Meanwhile, the 807th MAETS received some relief. On December 31, replacements for the missing squadron members began arriving. The squadron had only evacuated 1,477 patients in December. The unit history reported, "Our evacuation activities were slow and we all were anxious to get to work to get the war over with. But hospital ships being able to operate out of the port towns of Naples and Bari took a great deal of work from us."<sup>61</sup> Ships could sail when aircraft could not fly due to bad weather. Additionally, there were just fewer casualties because fighting died down along the Gustav Line (the German defenses across Italy blocking the Allied advance) after winter's onset. After New Year's Day most operations consisted of an hour flight from Foggia to Naples. The squadron's personnel were confined to the airfield ten miles outside Naples because of a typhus epidemic in the city. On January 8, 1944, the rest of the replacement flight nurses arrived, and four days later the replacement medical technicians, finally restoring the 807th MAETS to full strength.<sup>62</sup>

There was more good news. The missing 807th personnel in Albania had linked up with the OSS agent and reached the coast. They boarded a boat and finally arrived in Bari harbor on January 9, where they were greeted by a swarm of top brass and reporters. After two months, and a grueling journey of 340 miles (actually several times that total because of all the ascending and descending of moun-



The rescued flight nurses show their newly acquired boots, donated by the British. Their own shoes had fallen apart as a result of their months-long trek through hazardous terrain and blizzards in an attempt to reach Allied territory. (Air Force photo.)

tains), the four airmen, ten flight nurses, and thirteen medical technicians were safe.<sup>63</sup> One flight nurse and one medical technician were hospitalized in Bari, but the rest returned to the squadron in Catania on January 14. "Wonders never cease! It was this day our missing personnel returned almost in full, quite a bit for the worse, but very glad to get back," celebrated the unit history.<sup>64</sup> After two weeks, the missing departed for home, followed by the two others, because regulations dictated that anyone who crashed landed and escaped from enemy territory could not remain in that theater. A few of the flight nurses became instructors at Bowman Field while others went on a war bond tour with some of the medical technicians.<sup>65</sup> The 807th MAETS's high spirits soon dissipated, however.

The squadron was plagued by accidents and inactivity. On January 30, a jeep with three flight nurses overturned injuring all, one dying a few hours later. The 807th MAETS evacuated just 907 patients in January. The unit history blamed the British for being obstinate, but weather was bad and casualties were few in number. On February 24, a flight team transporting fifteen British patients, and one of the flight nurses injured in the jeep accident, became lost in bad weather and crashed into a mountain near Caltagirone soon after leaving Catania. The airplane exploded on impact killing everyone on board. The 807th MAETS lost four of its members to accidents in as many weeks while only evacuating 1,084 patients in February further lowering the squadron's morale.<sup>66</sup>

Spring's approach brought more work and some welcome good news ending the 807th MAETS's run of bad luck. "Air evacuation was beginning to get the recognition of an important function in the war," claimed the unit history.<sup>67</sup> This was true, but also more good weather meant more fighting, causing more casualties, and more opportunities to fly. After hearing that the rest of their comrades had escaped, the three flight nurses still hiding in Berat demanded to leave. On 18 March, a sympathetic Albanian





Radio reporter interviewing patients while in flight while a flight nurse looks on. Note the air conditioning vents in this larger transport aircraft from later in the war. (Army Nurse Corps Photographs Collection, AMEDD Center of History and Heritage Archives, Fort Sam Houston, Texas.)

BK soldier drove them hidden in the back of a truck using his pass to get by German checkpoints. Then Albanian LNC resistance members led them to British SOE agents. On March 21, the three flight nurses took a motorboat to freedom.<sup>68</sup> Six days later, they walked into the squadron's mess hall in Catania, and two days after that departed Sicily for the United States. During March, the 807th MAETS had its best month yet, air evacuating 2,331 (mostly British) patients. Although in April the squadron evacuated fewer patients, only 1,609 sick and wounded, it was again clear to its members that they were making a difference.<sup>69</sup>

### Peak Operations

As fighting intensified, and weather improved, the 807th MAETS only became busier. In early May, three replacement flight nurses and one medical technician arrived, so the squadron was again at full strength. Soon after the 807th MAETS was selected to put on a demonstration of air evacuation techniques for Lieutenant General Jacob Devers, the commander of the North African Theater of Operations, and Lieutenant General Ira Eaker, the commander-in-chief of the Mediterranean Allied Air Forces, at Ponte Olivia in Sicily. The mission to "sell" air evacuation remained an important one. The marriages of two flight nurses, promotion of most flight nurses, and decoration of many medical technicians later that month fur-

ther boosted morale.<sup>70</sup> The squadron was anxious to carry out its mission.

On May 23, after months of bloody stalemate, the Fifth Army in the Anzio beachhead began an offensive that broke through the German defenses as other Allied armies pierced the Gustav Line. With Allied armies now marching irresistibly northward, the 807th MAETS opened an air evacuation station at Anzio, which was now safe in the rear. In May, the squadron moved 2,006 patients, and for the first time most of them were American troops. The rest were primarily British soldiers but also French, Polish, and Italian troops plus German prisoners of war.<sup>71</sup> The Allied advance kept the 807th MAETS busy evacuating patients from Anzio and Bari by air to Naples. The flights lasted no more than an hour, so one two-person flight team often completed as many as five trips in a single day. First Lieutenant Stakeman proudly recorded, "It was in this period that we felt we were really doing the kind of evacuation that we had been trained for, as patients were gotten to the rear areas within sometimes twelve, and more frequently 24 to 36 hours after injuries. The battle casualties were severe, too, and it was more frequent than not, that the loading and placing of patients in the aircraft was a problem."<sup>72</sup> The 807th MAETS opened two air evacuation stations, while closing another, to keep up with the front. Patients in awkward casts were difficult to load; nevertheless, it usually took only ten or twenty minutes to embark everyone. The fall of Rome on June 5, the landings in Normandy



A flight nurse and a medical technician provide in-flight care to a patient. Flight nurses and medical technicians served in pairs forming a flight team. In extraordinary situations a flight team could be broken up and each member assigned an entire aircraft full of patients. (Army Nurse Corps Photographs Collection, AMEDD Center of History and Heritage Archives, Fort Sam Houston, Texas.)

the next day, and the growing number of German prisoners of war among squadron's patients raised hopes that the end of the war was close.

The 807th MAETS relocated from Sicily to Italy to be closer to the front. The squadron had been planning to move to Naples, but instead established itself at Lido di Roma twenty miles from the capital on June 28. Although the scenery was beautiful, the retreating Germans had wrecked the plumbing and electrical infrastructure. Moreover, the beach was "choked full" of mines. Squadron members periodically heard blasts when Italian soldiers clearing mines made a mistake or local civilians stumbled across one on the beach. A sector of the shoreline cleared of mines was used for bathing. The 807th MAETS evacuated 8,647 patients by air in June. Again, most were American, rather than British. Over one thousand were French soldiers who presented a challenge because their medical information was written in French and they most spoke only Arabic because they were North Africans.<sup>73</sup> The squadron now entered its most intense period of operations during the war.

Meanwhile, the Office of the Air Surgeon made some changes to the MAETSs. On July 19, after tweaking the number of enlisted men in each headquarters section, the MAETSs were redesignated Medical Air Evacuation Squadrons (MAESs). Recently promoted Major General Grant had dreamed of a fleet of "flying hospitals," but even with factories churning out airplanes, the AAF decided against dedicated aircraft for air evacuation. Instead, all transport aircraft from then on would be installed with

new web-strap litter supports.<sup>74</sup> Grant now changed his goal to MAESs providing "adequate care" to patients in flight. He concluded air evacuation was more about speed and safety than medicine. "Air evacuation is more logistical than medical in value," Grant opined.<sup>75</sup> The training courses at the AAF School of Air Evacuation had changed slightly. Flight nurses no longer helped train medical technicians. Moreover, candidates who wanted to become flight nurses or medical technicians had to serve for at least six months in the AAF or the ASF before becoming eligible.<sup>76</sup> By now, there were really three systems of air evacuation: intra-theater, inter-theater or theater to Zone of Interior, and Zone of Interior.<sup>77</sup>

The renamed 807th MAES now put its training and experience to good use as the fighting reached its peak in Italy. As the front advanced, the squadron opened four air evacuation stations and closed one to handle American and British patients. Another for French casualties operated for a short time. The squadron had its busiest month during July, air evacuating 13,625 patients, once more mostly British. The 819th MAES came from England to Italy to support the 802d and 807th MAESs in preparation for the Allied landings in southern France on August 15. A week later the first planeloads of patients started shuttling patients from southern France to Sicily and then on to North Africa. The Seventh Army took fewer casualties than anticipated, so the 819th MAES left the MTO to return to the ETO.<sup>78</sup> Suddenly, the 807th MAES was called upon for a special rescue mission in an unexpected direction.



## Romanian Rescue

Romania had been a key member of the Axis, providing most of the oil fueling the Nazi war machine and contributing a large number of troops to the eastern front. After an ineffectual, high-level air raid on the oil refineries at Ploiești on June 12, 1942 and a disastrous, low-level one on August 1, 1943, the Fifteenth Air Force began a sustained bombing campaign between April 5 and August 19, 1944. Romanian air defenses, reinforced by German forces, were very strong. The Fifteenth Air Force lost 2,829 airmen, including 1,123 captured, over Romania.<sup>79</sup> U.S. bombing had helped prepare the way for a Soviet offensive that smashed Romanian and German armies and caused the king of Romania to carry out a coup against the dictator of the country on August 23 to switch sides. Lieutenant Colonel James A. Gunn III, the senior American prisoner of war, immediately went to work trying to find someone in the new government to organize the transportation of the released American, and British, prisoners of war. Due to the unreliability of radio communications, the Romanian authorities decided to fly Gunn to Italy to help organize a rescue mission. On August 28, Gunn stuffed himself into the back of a German Bf 109 fighter behind the pilot seat of Captain Constantin M. Cantacuzino, a Romanian prince and a fighter ace. The Romanian fighter aircraft had U.S. flags painted on it to signal its peaceful intentions. The flight went smoothly and British anti-aircraft gunners did not shoot at the strangely decorated enemy fighter when it arrived. Gunn and other officers began planning how to rescue the Allied airmen while Cantacuzino was interrogated about the situation in Romania where German troops were battling Romanian soldiers after a failed counter-coup.<sup>80</sup>

Some Allied airmen would need medical attention because they were in bad health due to malnutrition and inadequate medical care. The following day, Captain Philip F. Voight, the flight surgeon in charge of the air evacuation station in Bari, was called into the office of Colonel Ottis O. Benson, Jr., the Fifteenth Air Force Surgeon, who requested the 807th MAES's assistance to air evacuate fifty patients from Bucharest. The plan initially consisted of using three C-47s with one medical technician each. Benson deemed the rescue mission too dangerous for flight nurses even though Voight told him "how disappointed the nurses will be when they find out they were not included."<sup>81</sup> Captain Cantacuzino was given a P-51 fighter, escorted by three others with orders to shoot him down if he deviated from the agreed upon plan, and flew back to Popești airfield outside the capital preparing the way for two B-17 heavy bombers to land and disembark an advance party to coordinate the rescue operation.<sup>8</sup> There were changes to the plan the next day on August 30. The Fifteenth Air Force planners determined the round trip was too long for C-47s to do on a single tank of fuel and they were too slow to be escorted by P-51s. Instead, they would use five B-17s, retrofitted to each fit six litter patients in the bomb bay plus four more in the body. Two more medical technicians were sent for while engineers went to work. Although they

labored through the night, engineers finished converting just two B-17s by morning. Benson decided to go ahead with only these airplanes with Voight and one medical technician. A coin toss determined which medical technician to go on what seemed an exciting adventure.<sup>83</sup>

All the planning paid off. The two B-17s, one with Colonel Benson and the other with Captain Voight and the medical technician, joined the last of three successive waves of B-17s each an hour apart that left Italy for Romania. After crossing the Adriatic Sea, P-51s appeared to escort them the rest of the way. The heavy bombers flew at just 10,000 feet, making the aircrews nervous because they normally did not fly this low, and took a zigzag route over Yugoslavia to avoid towns with German anti-aircraft guns. After two hours, a Romanian fighter doing aerial acrobatics and yellow flares from the ground signaled it was safe to land at their destination. The backbreaking work to raise the litter cases from the ground to the top of the bomb bays began immediately. Fortunately, the flight team discovered there were only ten litter and twenty-four sitting patients, so it only took 40 minutes to get everyone situated.<sup>84</sup> "The Romanians standing around, helped eagerly. They look very picturesque in their colorful, musical-comedy-like uniforms. Some of them touch us and run off giggling to their friends with an 'I touched an American' look on their faces. It is hard to believe that only a few days ago these people were supposed to be our enemies," reported Voight.<sup>85</sup> The return trip was uneventful – although other B-17s were jumped by enemy fighters that were driven off by P-51s. A total of 747 airmen were transported from Romania on August 31 to be greeted by a mob of press in Italy. Over the next three days another 419 liberated prisoners were rescued. Later missions brought back a final 105 men.<sup>86</sup> During August, the 807th MAES evacuated by air 5,985 patients, this smaller number the result of fewer casualties as the enemy retreated in haste.<sup>87</sup>

Yet casualties again began flooding in as Allied forces ran into German defenses along the Gothic line in northern Italy. The 807th MAES continued to air evacuate patients from Italy and France. Unlike the short flights within Italy, the flights to France and back began at dawn and often ended after dark, especially as the days began to shorten. These tiring missions were more dangerous because the longer the flight the greater the risk of airplane malfunction or pilot error. The weather was worsening, adding to the risk. On two occasions, transport aircraft with patients and medical personnel strayed over enemy-held territory and were fired upon. Despite long distances and muddy airfields, the squadron evacuated 1,786 patients by air from France to Italy and 10,242 others from Italy to Sicily or North Africa during September.<sup>88</sup> This was the end to major air evacuation operations in the MTO, however.

## Experiments with Light Aircraft

There were developments in air evacuation in other theaters regarding the use of light aircraft and even helicopters. After successful flight demonstrations in April 1942, the Army ordered helicopters for the AAF in March

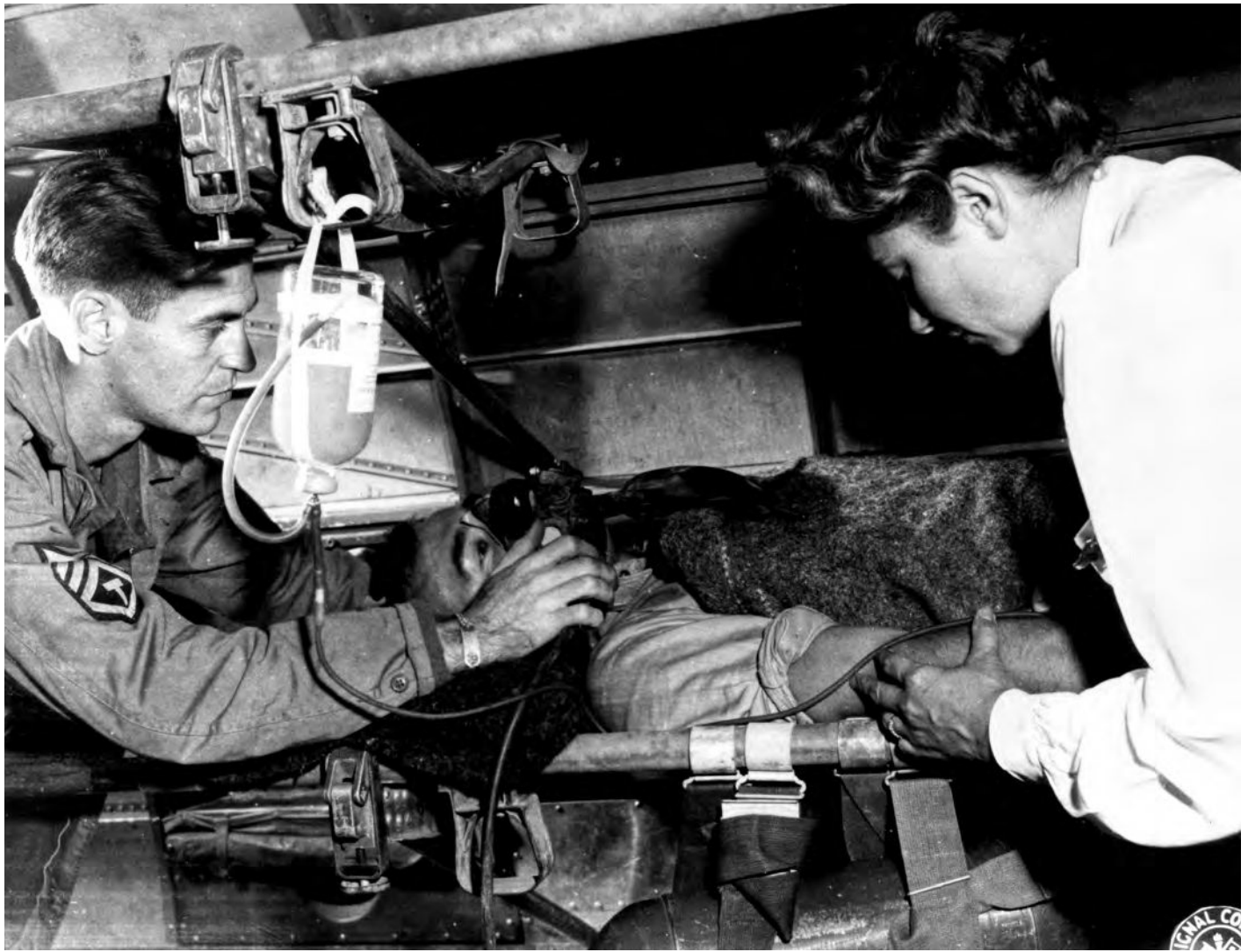

Lieutenant Irene P. Brown administers plasma on a patient in flight as Sergeant Robert C. Gilchrest administers oxygen. (Army Nurse Corps Photographs Collection, AMEDD Center of History and Heritage Archives, Fort Sam Houston, Texas.)

1943. Tests quickly demonstrated their usefulness in air evacuation. The YR-4B helicopters of the 1st Air Commando Group, hurriedly retrofitted to carry litters, were the first to air evacuate casualties in April 1944 when a stranded group of AAF commandos with wounded needed rescuing in Burma.<sup>89</sup> Helicopters remained few in number, so they could not be used for air evacuation on a large scale. Furthermore, they were unable to carry a medical attendant along with the pilot to provide in-flight care to the patients.

The ad-hoc use of light aircraft to evacuate patients by air expanded over time and even became routine in some places. In September 1944, after the breakout from Normandy in the ETO, the underemployed UC-64 light transport aircraft (which could hold three litter cases each) of the 320th Transport Squadron were placed at the Theater Surgeon's disposal to help speed patients and medical supplies back and forth between France and Britain. A trip that had required several days, now took only a couple of hours. Over three months the 320th Transport Squadron helped eliminate a backlog of patients needing evacuation.<sup>90</sup> The difficult terrain in Luzon made air evacuation invaluable once fighting started on the island in January

1945 during the liberation of the Philippines. R-6 helicopters operated in remote mountains, again without medical attendants, but light aircraft made a greater contribution. Light aircraft were also used to air evacuate casualties in Okinawa later that summer. Eventually, in addition to the MAESs already operating in the PTO, three squadrons of L-5 liaison aircraft were allocated to the Far East Air Force for use in air evacuation.<sup>91</sup>

Such air ambulances were not used in the MTO. After a few flights using L-5s in Italy in April 1945, further air evacuation missions were suspended as only one patient, and no medical attendant, could fit in the airplane.<sup>92</sup> Light aircraft and helicopters lifted only a tiny number of the total patients evacuated by air during the war, but they proved General Grant had been right about their usefulness in air evacuation of casualties from the front in certain contexts.

### Final Operations

The MAESs continued their lifesaving work around the globe during the last year of the war. As opposing armies





A flight nurse and a medical technician, in a less posed photograph, tend patients. (Army Nurse Corps Photographs Collection, AMEDD Center of History and Heritage Archives, Fort Sam Houston, Texas.)

settled in for the winter in Italy, the number of casualties declined. In October 1944, the 807th MAES air evacuated only 7,285 patients. On November 7, the squadron discontinued flights between France and Italy. The 807th MAES air evacuated 3,464 patients in November and 3,897 more in December. By Christmas, most members of the squadron received the Air Medal and two battle stars. Many flight nurses were promoted to first lieutenant and chief flight nurse Stakeman to captain. Medical technicians received the Air Crew Member Aviation Badge.<sup>93</sup> The unit history indicates bad weather was the squadron's greatest challenge. "Adverse weather conditions more than any other factor have hindered Air Evac. Every attempt has been made to carry on our work during this period, in spite of the weather as evidence by the increased number of dry runs made by flying personnel only to find that due to poor visibility they were unable to land at the forward fields."<sup>94</sup> There was an increase of patients with hepatitis and trench foot due to the filth, wet, and cold in the trenches on the front. The 807th MAES air evacuated 490 patients in January, 1,546 in February, and 1,846 in March.<sup>95</sup>

The squadron greeted spring with mixed feelings because as the weather improved, flying became easier but fighting also increased. The 807th MAES joined the 802d MAES to operate an air evacuation station at Florence to lift American soldiers to Pisa, Rosignano, Rome, or Naples. The personnel for each flight was half from one squadron and half from the other. On April 6, 1945, the last Allied of-

fensive began in northern Italy, which broke through the Gothic Line. The 807th MAES evacuated 4,027 patients by air in April. German forces in Italy surrendered on May 2, and a week later, the war in Europe was over. The squadron evacuated 947 patients by air during May as it closed air evacuation stations including at Florence and Bari.<sup>96</sup>

The 807th MAES received orders to wrap up in the MTO and prepare to ship out to the PTO. On June 1, the 807th MAES took over all air evacuation missions in the MTO after the 802d MAES became non-operational. Both squadrons sent home their personnel who had been in theater the longest and had the requisite number of points for demobilization. The remaining personnel were amalgamated. On June 3, three transport aircraft left Rosignano for Pisa. There they picked up Russian patients. These were Soviet soldiers or civilians who had been captured by the German Army on the eastern front and assigned to German labor or service units. The squadron flew them to Bruck in Austria, but there were no facilities to receive them. Therefore, they continued to Vienna, deep in the Soviet zone of occupation. "Our crews and the Russian patients were not welcome. It took great persuasion on the part of the crews to convince the Russians they should accept their own wounded soldiers...It seemed that Russians who allowed themselves to become prisoners were disgraced, hence the frigid unwelcome they received."<sup>97</sup> When the Americans tried to take off, the Soviets threatened to open fire and detained them as "prisoner guests" before releasing them after three days. Fortunately, this brush with Stalinist paranoia was more annoying than frightening, and the unit history just chalked it up to poor communication due to the language barrier. The 807th MAES air evacuated 1,210 patients in June and 1,463 in July, which were its last of the war.<sup>98</sup>

The war ended before the squadron left for the PTO. Over three years, the 802d, 807th, and 819th MAESs transported 212,285 patients by air across the MTO. There were only three deaths in flight. Another thirty patients died in plane crashes near Caltagirone in Sicily, already mentioned, and St. Chaumont in France (in which a flight nurse from another squadron died).<sup>99</sup> On August 1, the 807th MAES became non-operational. Six days later the squadron moved to Naples to embark for Manila in the Philippines, however, news of the atomic bombs dropped on Hiroshima and Nagasaki, on August 6 and 9 respectively, and rumors the Japanese would soon surrender halted it. Instead, on August 21, flight nurses departed for Boston. Flight surgeons, medical technicians, and enlisted men followed a few days later but docked in New York. The war in the Pacific ended on September 2. All medical technicians and non-medical enlisted men plus most flight nurses now had enough points to be discharged. The remaining four flight surgeons, one Medical Administrative Corps officer, and eight flight nurses reassembled at Randolph Field in Texas in October.<sup>100</sup>

Randolph Field had become the new home of air evacuation. On October 15, 1944, the AFF School of Air Evacuation, now under Lieutenant Colonel John R. McGraw, had

been shut down and transferred to the School of Aviation Medicine located at Randolph Field. The School of Aviation Medicine had established the Department of Air Evacuation under Major Russel C. Smith.<sup>101</sup> Flight surgeon training had remained an orientation course lasting two weeks. Flight nurse training had been extended by a week to a nine-week course divided into three phases of medical, military, and practical coursework.<sup>102</sup> Medical technician training had been reduced to a three-week air evacuation course (after the two-week nursing course taught by flight nurses was suspended); however, they first completed a six-week field medical training course at Robins Field near Macon, Georgia.<sup>103</sup> Toward war's end, some medical technicians thought they were trained well enough to do the job without flight nurses. The Twelfth Air Force conducted a study concluding that even well trained medical technicians could not replace skilled flight nurses.<sup>104</sup> Major Frederick R. Glassford headed the Department of Air Evacuation after January 26, 1945. The School of Air Evacuation and the School of Medical Aviation Department of Air Evacuation trained 1,409 flight nurses and a similar number (exact figures are lacking) of medical technicians during World War II.<sup>105</sup> The AAF had created a total of thirty MAESs (801st-829th and 831st), but inactivated them all on December 11, 1945.

## Conclusion

The efforts of General Grant, the Office of the Air Surgeon, and the MAESs proved the value of air evacuation during World War II. Consequently, air evacuation became increasingly important in each conflict that followed. After the creation of the independent Air Force in 1947, responsibility for air evacuation was split. The Army retained control of rotary-wing aircraft. The helicopters used in the

Korean War still lacked room for medical personnel, but by the Vietnam War, helicopters had become true air ambulances capable of transporting litter cases and medical attendants from battlefield to hospital. The Air Force remained responsible for air evacuating patients by fixed-wing aircraft. The number of patients evacuated by air from hospitals in the rear in Korea and later in Vietnam (usually first to hospitals in Japan before continuing to the United States) grew. Additionally, transport aircraft became larger, more reliable, and better able to navigate through bad weather. Consequently, aircraft steadily displaced trains and ships as the preferred means of evacuating patients during these Cold War conflicts.

Since World War II, no foe of the United States has possessed the ability to prevent air evacuation of casualties out of theater. The handful of casualties in the Gulf War, and apparent lack of major rivals after the end of the Cold War, convinced the Army to shrink the number of hospitals to be deployed in theater and rely even more on the Air Force to air evacuate sick or wounded soldiers to hospitals in Europe or even the United States. This became routine during the wars in Iraq and Afghanistan. The School of Aerospace Medicine at Wright-Patterson Air Force Base near Dayton, Ohio, includes the School of Aeromedical Evacuation that trains flight nurses and medical technicians. The Air Force currently has four active, eighteen reserve, and nine Air National Guard Aeromedical Evacuation Squadrons – still lacking organic transport aircraft and aircrews. The U.S. military is now preparing for Multi-Domain Operations with a near peer rival. This doctrine assumes each domain (land, sea, air, space, and cyber) will be contested, so it cannot be assumed that air supremacy will be continuous and assured in a future conflict. It is worth looking back to air evacuation in World War II to see what lessons can be relearned. ■

---

## NOTES

1. Robert F. Futrell, *Development of Aeromedical Evacuation in the USAF, 1909-1960* (Maxwell Air Force Base, AL: Research Studies Institute Air University, 1960), 72.
2. Quoted in Mae Mills Link and Hubert A. Coleman, *Medical Support of the Army Air Forces in World War II* (Office of the Surgeon General, USAF: Washington, D.C., 1955), 369.
3. Quoted in *ibid.*, 371.
4. Quoted in *ibid.*, 411-412.
5. *Ibid.*, 352, 18-19, 357.
6. Futrell, *Development of Aeromedical Evacuation in the USAF*, 57.
7. *Ibid.*, 58.
8. *Ibid.*, 59.
9. Link and Coleman, *Medical Support of the Army Air Forces in World War II*, 360; Clarence McKittrick Smith, *The Medical Department: Hospitalization and Evacuation, Zone of Interior* (Washington D.C.: Officer of the Chief of Military History, 1956), 438.
10. Link and Coleman, *Medical Support of the Army Air Forces in World War II*, 359-360

11. *Ibid.*, 361.
12. Smith, *Medical Department: Hospitalization and Evacuation, Zone of Interior*, 439.
13. Futrell, *Development of Aeromedical Evacuation in the USAF*, 77.
14. *Ibid.*, 74-75.
15. Link and Coleman, *Medical Support of the Army Air Forces in World War II*, 367.
16. Futrell, *Development of Aeromedical Evacuation in the USAF*, 80-81.
17. Link and Coleman, *Medical Support of the Army Air Forces in World War II*, 368.
18. *Ibid.*, 78-79.
19. Futrell, *Development of Aeromedical Evacuation in the USAF*, 91.
20. Quoted in *ibid.*, 92.
21. 807th Medical Air Evacuation Squadron Unit History by Grace H. Stakeman, Box 317, Folder 23, Army Nurse Corps Collection, ACHH Archival Repository, 1-2. [807th Medical Air Evacuation Squadron Unit History, Army Nurse Corps Collection.]



22. Futrell, *Development of Aeromedical Evacuation in the USAF*, 82.
23. Link and Coleman, *Medical Support of the Army Air Forces in World War II*, 373.
24. Cate Lineberry, *The Secret Rescue: An Untold Story of American Nurses and Medics behind Nazi Lines* (New York: Little, Brown and Company, 2013), 8.
25. Link and Coleman, *Medical Support of the Army Air Forces in World War II*, 374.
26. Lineberry, *Secret Rescue*, 8-9.
27. *Ibid.*, 11-12.
28. 807th Medical Air Evacuation Squadron Unit History, Army Nurse Corps Collection, 3.
29. Link and Coleman, *Medical Support of the Army Air Forces in World War II*, 378.
30. Futrell, *Development of Aeromedical Evacuation in the USAF*, 89.
31. Lineberry, *Secret Rescue*, 13.
32. Link and Coleman, *Medical Support of the Army Air Forces in World War II*, 374.
33. Futrell, *Development of Aeromedical Evacuation in the USAF*, 91.
34. 807th Medical Air Evacuation Squadron Unit History, Army Nurse Corps Collection 4-5.
35. Lineberry, *Secret Rescue*, 20.
36. 807th Medical Air Evacuation Squadron Unit History, Army Nurse Corps Collection, 6.
37. *Ibid.*, 7.
38. *Ibid.*, 8.
39. *Ibid.*, 9.
40. Link and Coleman, *Medical Support of the Army Air Forces in World War II*, 482.
41. Agnes Jensen Mangerich, *Albanian Escape: The True Story of U.S. Army Behind Enemy Lines*, eds Evelyn M. Monahan and Rosemary L. Neidel (University Press of Kentucky: Lexington, 1999), 10.
42. 807th Medical Air Evacuation Squadron Unit History, Army Nurse Corps Collection, 9-10.
43. Lineberry, *Secret Rescue*, 37-38, 45-48.
44. Mangerich, *Albanian Escape*, 5-7; Lineberry, *Secret Rescue*, 55.
45. Lineberry, *Secret Rescue*, 70.
46. Mangerich, *Albanian Escape*, 47, 53, 54-61, 73; Lineberry, *Secret Rescue*, 222, 224.
47. 807th Medical Air Evacuation Squadron Unit History, Army Nurse Corps Collection, 12.
48. *Ibid.*
49. Link and Coleman, *Medical Support of the Army Air Forces in World War II*, 479.
50. Futrell, *Development of Aeromedical Evacuation in the USAF*, 86.
51. 807th Medical Air Evacuation Squadron Unit History, Army Nurse Corps Collection, 13.
52. Link and Coleman, *Medical Support of the Army Air Forces in World War II*, 478.
53. 807th Medical Air Evacuation Squadron Unit History, Army Nurse Corps Collection, 14.
54. Link and Coleman, *Medical Support of the Army Air Forces in World War II*, 478.
55. Futrell, *Development of Aeromedical Evacuation in the USAF*, 103-104.
56. Mangerich, *Albanian Escape*, 111-112.
57. 807th Medical Air Evacuation Squadron Unit History, Army Nurse Corps Collection, 15.
58. *Ibid.*, 16.
59. Lineberry, *Secret Rescue*, 120.
60. Mangerich, *Albanian Escape*, Pg.134, 163-165.
61. 807th Medical Air Evacuation Squadron Unit History, Army Nurse Corps Collection, 16.
62. *Ibid.*, 17.
63. Lineberry, *Secret Rescue*, 217-218.
64. 807th Medical Air Evacuation Squadron Unit History, Army Nurse Corps Collection, 17.
65. Mangerich, *Albanian Escape*, 212.
66. 807th Medical Air Evacuation Squadron Unit History, Army Nurse Corps Collection, 18-20.
67. *Ibid.*, 20.
68. Lineberry, *The Secret Rescue*, 230-234.
69. 807th Medical Air Evacuation Squadron Unit History, Army Nurse Corps Collection, 21.
70. *Ibid.*, 22.
71. *Ibid.*
72. *Ibid.*, 23.
73. *Ibid.*, 24-25.
74. Futrell, *Development of Aeromedical Evacuation in the USAF*, 94-96.
75. *Ibid.*, 105.
76. *Ibid.*, 88.
77. *Ibid.*, 72.
78. 807th Medical Air Evacuation Squadron Unit History, Army Nurse Corps Collection, 25-27.
79. Marx Axworthy, Cornell Scafes, and Christian Craciunoiu, *Third Axis, Fourth Ally: Romanian Armed Forces in the European War, 1941-1945* (St. Petersburg, FL: Hailer, 1995), 311-314.
80. Jay A. Stout, *Fortress Ploesti: The Campaign to Destroy Hitler's Oil* (Havertown, PA: Casemate, 2011), 232-234.
81. 807th Medical Air Evacuation Squadron Unit History, Army Nurse Corps Collection, 27-28.
82. Stout, *Fortress Ploesti*, 234-235.
83. 807th Medical Air Evacuation Squadron Unit History, Army Nurse Corps Collection, 28.
84. *Ibid.*, 28-29.
85. *Ibid.*, 30.
86. Stout, *Fortress Ploesti*, 236.
87. 807th Medical Air Evacuation Squadron Unit History, Army Nurse Corps Collection, 27.
88. *Ibid.*, 31
89. Peter Dorland and James Nanney, *Dust Off: Army Aeromedical Evacuation in Vietnam* (Washington D.C.: U.S. Army Center of Military History, 2008), 9.
90. Graham A. Cosmas and Albert E. Cowdrey, *The Medical Department: Medical Service in the European Theater of Operations* (Washington, D.C.: U.S. Army Center of Military History, 1992), 332-334.
91. Mary Ellen Condon-Rall and Albert E. Cowdrey, *The Medical Department: Medical Service in the War against Japan* (Washington, D.C.: U.S. Army Center of Military History, 1998), 348, 407, 415.
92. Charles M. Wiltse, *The Medical Department: Medical Service in the Mediterranean and Minor Theaters* (Washington, D.C.: U.S. Army Center of Military History, 1987), 460.
93. 807th Medical Air Evacuation Squadron Unit History, Army Nurse Corps Collection, 35.
94. *Ibid.*, 37.
95. *Ibid.*, 39.
96. *Ibid.*, 40-41
97. *Ibid.*, 42.
98. *Ibid.*, 40.
99. Link and Coleman, *Medical Support of the Army Air Forces in World War II*, 486.
100. 807th Medical Air Evacuation Squadron Unit History, Army Nurse Corps Collection, 43.
101. Futrell, *Development of Aeromedical Evacuation in the USAF*, 1909-1960, 83.
102. *Ibid.*, 88.
103. Link and Coleman, *Medical Support: Army Air Forces in World War II*, 380.
104. Futrell, *Development of Aeromedical Evacuation in the USAF*, 92.
105. *Ibid.*, 89-90.

**Pacific Profiles, Volume Six, Allied Fighters: Bell P-39 & P-400 Airacobra, South & Southwest Pacific 1942-1944.** By Michael Claringbould. Kent Town, Australia: Avonmore Books, 2022. Glossary. Maps. Photographs. Sources. Index. Pp. 120. \$42.95 paperback. ISBN: 978-0-6452469-0-2.

A prolific author, Michael Claringbould is a three-dimensional, digital aviation artist and globally recognized expert on Japanese aviation and the Pacific air war. He is a contributing editor for *Flight Path* magazine and is the author of several books on the Fifth Air Force and World War II Pacific history. He is a member of Pacific Air War History Associates. While growing up in Papua New Guinea in the 1960s, he became fascinated by Pacific air war aircraft. He has assisted both with the recovery and identification of such aircraft and has helped both the US and Japanese governments in identification of missing aircraft crews.

The Pacific Profiles series presents artistic profiles of aircraft which served in the South Pacific theater during World War II. This volume covers Bell Airacobra aircraft. These were used in a variety of roles including fighting, dive-bombing, and strafing. Airacobras served in a dozen USAAF Fifth and Thirteenth Air Forces squadrons starting with the early Bell P-400s and P-39D/F/K models, and then the late model P-39N/Q Airacobras from April 1942 until March 1944. Claringbould begins with an introductory chapter describing the different Airacobra models, their introduction into combat, and the early bases from which they operated in the Southwest Pacific theater. He follows with an overview of aircraft markings and their development which include national insignia, serial numbers, theater and formation markings, squadron insignia, and nose art. Claringbould organized the book into twelve chapters, each dedicated to a specific squadron. These chapters include an overview of the squadron's service, and profile markings and supporting photographs of selected aircraft along with a brief note on the status of each. An additional chapter includes Airacobra-unique marking design features and follows the marking profiles of one aircraft through its history.

This book provides a nice overview of Airacobra service in the Southwest Pacific Theater. It serves to clarify the hodgepodge of markings and rationale for their application that followed individual aircraft through their often-continuous transfer from squadron to squadron. It is a quick read and will provide a good reference for both modelers and those interested in one facet of early air combat in that theater of the war.

*Frank Willingham, NASM Docent*



**South Pacific Air War Volume 5: Crisis in Papua, September – December 1942.** By Michael Claringbould and Peter Ingman. Kent Town, Australia: Avonmore Books, 2022. Glossary. Abbreviations. Notes. Appendices. Maps. Tables. Photographs. Sources. Index. Pp. 236. \$48.95 paperback. ISBN: 978-0-6489262-9-0

This is another of prolific author Michael Claringbould's many books on air warfare in the South West Pacific theater of war. This time, he joins with Peter Ingman, an acclaimed military aviation historian and a former business executive with a key interest in the early stages of the Pacific war. Ingman has traveled widely throughout northern Australia and the South Pacific conducting research for his books.

This fifth volume of the series chronicles aerial warfare in the New Guinea theater during the critical period between September and December 1942. It can be read alone or as a continuation of the previous volumes which span the first nine months of the Pacific war.

This volume covers the activities of the newly formed Fifth Air Force which was established to coordinate the USAAF and RAAF units in New Guinea. Its primary directive was to provide close air support, aerial supply, and interdiction of Japanese convoys. Also described are Japanese activities from bases in New Britain and New Ireland. From the allied point of view, this period was one of extreme crisis. September saw the Japanese land forces that threatened Port Moresby and its valuable air bases in Papua by advancing over the Owen Stanley Range via Kokoda (thus the Crisis in Papua subtitle). At the same time, US forces in the Solomons were struggling to secure Guadalcanal. Allied aerial losses were extremely high, but the Japanese also faced heavy losses during their defense of the Solomons and were forced to redeploy units from Southeast Asia to reinforce their New Guinea campaign. From 9 September to 31 December, the Allies lost 115 aircraft of all types, while the Japanese lost 51. Unlike the Japanese, Allied forces were heavily involved in direct air support: they flew some 2000 sorties over the Kokoda Track alone. Meanwhile, the Japanese were facing a growing problem of having to replace losses with inexperienced crews. The end of 1942 saw the Allies close to victory in Papua and the Japanese planning to evacuate Guadalcanal. However, the Pacific war was far from over.

As in previous volumes, this narrative provides a day-by-day account of the aerial encounters between Australian, Japanese, and American sea- and land-based aircraft.

The authors match Allied operational accounts with those from Japanese records to provide a broader view. Daily sorties from both sides are recounted. Pilots had to deal with constantly changing weather across the theater of operations and were hindered by the mountainous terrain separating the Japanese forces at Rabaul from the Allied forces at Port Moresby and northern Australia.



The book provides data on personnel involved on both sides. Photographs and graphics are employed throughout. Several theater maps are provided. The three-dimensional graphic portrayals of aircraft in action are particularly well-done and add much to the total presentation.

I found this to be just as excellent as the previous volumes. It is well-written, easy to comprehend, and an excellent source for the aircraft enthusiast or Pacific air war researcher alike.

*Frank Willingham, NASM docent*



**The Mosquito in the USAAF.** By Tony Fairbairn. Haverford PA: Air World, 2021. Glossary. Photographs. Appendices. Bibliography. Index. Pp. x, 291. \$42.95. ISBN: 978-139901-733-6

Many books have been written about the de Havilland Mosquito, but few have given so much as a chapter to its service in the USAAF. Tony Fairbairn fills a much-needed gap with this volume, examining the role it played in reconnaissance, special operations, and night fighting. This is one to add to your bookshelf.

Elliott Roosevelt was an early advocate of adding the Mosquito to America's reconnaissance fleet; the first chapter is devoted to his efforts. The remainder of the book is devoted to the various missions the type performed in American service.

The second, and longest, chapter covers the 802nd (later 25th) Bomb Group, which carried out photoreconnaissance and weather reconnaissance missions over Europe using the Mosquito PR.XVI. They also dispersed chaff ahead of the AAF heavies, conducted H2X radar mapping of targets, and were early LORAN testbeds. As if that wasn't enough, they were tasked with providing photo coverage of the unmanned bombers used for *Aphrodite* / *Anvil* missions, and of Operation *Batty* TV-guided 2000-lb bombs. These last roles weren't as safe as might be thought. One Mossie was damaged when the *Anvil* PB4Y-1 (B-24) being flown by Lt Joseph Kennedy, Jr., exploded prematurely. Another was lost when it flew past an unexploded *Batty* just as it went off.

The 416th Night Fighter Squadron's story encompasses the development of night fighters for the USAAF, culminating in the Northrop P-61. The US started with A-20/P-70 aircraft, but soon after being deployed in May 1943, they converted to Bristol Beaufighters which they operated for most of their time overseas. The 416th then moved to the Mediterranean where they supported Allied operations in the area, re-equipped with Mosquito NF.XXX models in December 1944, and started conversion to the P-61 in early May 1945.

The 492nd BG, also operating the Mosquito PR.XVI, supported the Office of Strategic Services (OSS) for Joan-

Eleanor missions, short-range radio communications with Allied agents in occupied Europe. Here, the Mosquito's capabilities came to the fore. As UHF signals are essentially line-of-sight, an orbiting Mosquito could receive transmissions what ground-based radio direction finders wouldn't hear.

The Mosquitos built in Canada for the USAAF, and given the US designation F-8, were variants of the B.IV (RAF designations B.VII and B.XX) with Packard-Merlin engines. Only a few of the 40 ordered made it overseas, the bulk of USAAF demands being supplied from British production. Two Canadian Mosquitos and one FB.XVIII were allotted, or at least demonstrated, to the US Navy.

Running through the book are the adjustments the Americans had to make to cope with differing US and British conventions, such as converting manifold pressure between inches and pounds, and dealing with the torque from the two Merlin engines. One can only wonder how the mechanics of the 416th felt about the Beaufighter's sleeve-valved Hercules engines.

Appendices include serial numbers (and dispositions) of USAAF Mosquitos, losses, and a chronology of the type in the USAAF. My only niggles are that one photo is duplicated on different pages, and the history of the NMUSAF's Mosquito B.35 (RS709) is mixed with that of Kermit Weeks' B.35 (RS712) at the EAA Museum. But then, I'm a Mosquito nerd.

*Jon Barrett, Collections Volunteer, National Air & Space Museum*



**B-25 Mitchell vs. Japanese Destroyer: Battle of the Bismarck Sea 1943.** By Mark Lardas. New York: Osprey, 2021. Map. Tables. Diagrams. Illustrations. Photographs. Index. Pp. 80. \$22 paperback. ISBN: 978-1-147284518-4

As a former engineer with a passion for history, Lardas previously focused his publishing efforts on naval history. In this effort, he uses his background in marine engineering to contribute to Osprey's long-running duel series with volume No. 116.

The duel series typically compares adversarial military equipment, naval vessels, or combat aircraft. Occasionally, these adversaries are a mixture of two of the three types (e.g., volumes that have featured US Vietnam-era aircraft against North Vietnamese defensive systems).

This work follows the standard Osprey formula: a chronology, design and development, technical specifications, strategic situation, combatants, combat, statistical analysis, and the aftermath.

In March 1943, American and Australian aircraft successfully attacked and sank Imperial Japanese Navy destroyers and transports attempting to move troops from the Japanese bastion of Rabaul (at the east end of New

Britain) to the north coast of New Guinea. To do so, the Japanese convoy transited the Bismarck Sea, where the Allied aircraft intercepted it.

Fifth Air Force crews flying the North American B-25 Mitchell medium bomber inflicted the most damage. They accomplished this because they had trained extensively in low-level bombing, either from “mast-top” height using delayed fuses or by skipping bombs across the water. However, these tactics were only possible because the B-25s had been modified to incorporate multiple .50-caliber machine guns in the nose and, later, in side blisters. Aggressive strafing enabled the B-25 crews to neutralize the destroyers’ limited anti-aircraft capability.

The book emphasizes the field modifications to the B-25, a story told whenever the exploits of the Fifth Air Force are recalled. It also provides an adequate summary of the battle and mentions the contributions of other aircraft such as the Douglas A-20 Havoc, Consolidated B-24 Liberator, and Lockheed P-38 Lightning. Of course, the destroyers’ fundamental anti-aircraft deficiencies are discussed.

Osprey excels at packaging information by blending photographs, color illustrations, diagrams, and tables. However, the narrative can vary considerably from one work to the next. In this case, the notion of a duel between the B-25 and the destroyer seems very misleading. The Japanese vessels had no chance against the B-25’s superior fire power, especially when pairs of aircraft worked as a team with one suppressing the anti-aircraft guns and the other dropping the bombs.

Despite the text seeming somewhat repetitive, Lardas wasted no words on why the Japanese fighter cover disappeared. Perhaps those pilots were totally intimidated by the presence of P-38s. Also, in the aftermath, any reference to how modified B-25s might have been employed in the Mediterranean Theater was omitted. What about the Brits? Did they use modified Mitchells, and, if so, how?

Readers new to the B-25 and the Battle of the Bismarck Sea will find this effort an adequate starting point. Since the Osprey format dispenses with the citations of sources, it is assumed much of the information came from the “Further Reading” list at the back of the book.

*Steven D. Ellis, Lt Col, USAFR (Ret), docent, Museum of Flight, Seattle WA*



**Fighter ‘Gator.** By John E. Norvell. Self-published, 2021. Photographs. Notes. Glossary. Appendix. Pp. vi, 262. \$19.95 paperback. ISBN: 978-1-09839-733-3

Direct from undergraduate navigator training (UNT), survival schools, and transition training, then-Captain Norvell joined the 13th Tactical Fighter Squadron of the 432nd Tactical Reconnaissance Wing at Udorn Air Base, Thailand in early 1973. He flew missions in the back seat

of the F-4 Phantom II as the Weapons Systems Officer (WSO)—the GIB (guy in back). Between May 28 and August 15 of that year, he flew 42 combat missions over Cambodia. This closing chapter in the Vietnam war aimed to reduce pressure on the struggling South Vietnamese government from the Khmer Rouge. Congress had legislated that combat operations from Thailand cease at noon on August 15. Unexpectedly, Norvell flew the last official mission.

*Fighter ‘Gator* is neither a formal history of the air war over Cambodia nor an overall account of his squadron’s operations. Rather it is an intimate, personal narrative of one air warrior’s journey.

Coming from a line of men who served in the nation’s wars, Norvell graduated from Hobart College in 1966 with an Air Force ROTC commission. He expected to fly, but he was medically disqualified at the last moment. He spent four humdrum years at Bolling AFB in Washington. He was thrilled when another medical evaluation cleared him to become a navigator.

At one level, the book relates the challenges of UNT, survival and transition training, combat missions, homecoming, and subsequent assignments: Alaska (43rd Tactical Fighter Squadron and 21st Composite Wing); teaching history at the USAF Academy; and a tour at the navigation school at Mather AFB, California. Along the way he gives his accounts of survival training (basic/POW, water, jungle, and arctic), the air war from the back seat of an F-4, squadron life and its occasional hijinks, air refueling, alert duty, intercepts, and travel. He introduces barf bags and “the trots” too.

At a deeper level, Norvell relates how the demands of navigation, so intimidating for a history major, yielded to disciplined study, and how training made him “careful, precise, systematic, and well-organized.” “I had to do the work.” “There is no coasting in combat.” And “when you fly in the military, there is a path that you follow”—flying student, earning your wings, aircraft qualification, squadron member, and instructor for others. “Each time you move up a rung on the ladder. And each time you move, there is another rung.”

Norvell also added an introspective chapter on duty, honor, country, trust, dedication, and loyalty. “Combat made me a better person.” This, then, is the ideal book to give to a cadet or student considering a flying career in the armed forces. It previews coming chapters in a military aviator’s life. And it introduces the larger concepts that must guide it.

The volume includes a 29-page appendix by David Garbe, who little by little found the parts and assemblies to restore an F-4D cockpit. It opens a window on the difficult but fascinating work of aircraft restoration.

*Donald M. Bishop, Department of History, USAF Academy*





**A History of the Mediterranean Air War 1940 - 1945 Volume Five: From the Fall of Rome to the End of the War 1944 - 1945.** By Christopher Shores and Giovanni Massimello with Russell Guest, Frank Olynyk, Winfried Brock, and Andrew Thomas. London: Grub Street, 2021. Maps. Photographs. Appendix. Indices. Pp. 526. \$75.95. ISBN: 978-1-911621-97-3

Christopher Shores, the lead author, is among the world's foremost authorities on military aviation history. Over the years, he has authored or co-authored dozens of books for various publishers. A project as ambitious as this five-volume series (*Volume One* was published in 2012), however, most likely could be completed only with a team effort. For example, Frank Olynyk is recognized as one of the top experts on American victory claims in World War II.

Organized into two parts, this volume offers a day-by-day accounting of tactical air activity (for the most part, the US Fifteenth Air Force strategic-bombing campaign is ignored). The first part, "The Air War over the Aegean," falls outside the title's time line. The first of two chapters begins with entries dating from May 1943. The second and final chapter concludes with entries in early June 1944. In the preamble, the authors explain that this portion of their research fit better in the final volume.

The second part, "Italy and the Balkans from June 1944," carefully examines a portion of World War II's air war that, for the most part, has been ignored by historians. This omission occurred primarily because of the attention devoted to the battle for France beginning in June 1944. However, the air war associated with Operation *Dragoon*, the US-led invasion of southern France in August, receives a detailed look.

Usually I read a book cover to cover. Because of the overwhelming amount of facts, I chose to selectively examine the detailed day-by-day entries rather than read every one. A typical daily summary begins with a synopsis followed by the victory claims and losses for all belligerents believed to have engaged in aerial combat on that date. Using the index, I located an entry for First Lieutenant Albert L. Jones. Jones, the Boeing Company's former chief pilot for flight-crew training, downed a German Ju 87 near Asola, Italy, at 2130 hours on the evening of December 23 while flying a Beaufighter VI for the 414th Night Fighter Squadron. This is one example of the detail presented.

From time to time, the authors provide a lengthier narrative. Sometimes these passages examine a particular operation or unusually intense combat. Occasionally, they summarize the prior month's activities and transition into the upcoming month.

This work belongs in the reference library of any student of aerial operations in the Mediterranean. While the text and photographs emphasize the contributions of British Commonwealth pilots and their units, countries besides Germany and the United States are included—e.g.,

the efforts of Italians fighting for and against the Allies. The three indices are organized by pilot nationalities, unit nationalities, and places.

*Steven D. Ellis, Lt Col, USAFR (Ret), docent, Museum of Flight, Seattle WA*



**We Were Never There Volume 2: CIA U-2 Asia and Worldwide Operations 1957-1974.** By Kevin Wright. Warwick UK: Helion & Co, 2022. Maps. Tables. Diagrams. Illustrations. Photographs. Notes. Appendices. Bibliography. Index. Pp. 90. \$29.95 paperback. ISBN: 978-1-915070-69-2

Flying operationally from 1956, U-2 overflights began over the USSR, Eastern Europe, and the Middle East. The public loss of U-2 pilot Gary Powers near Sverdlovsk on 1 May 1960 eclipsed many other achievements of the U-2. Those U-2 operations are covered in some detail in the first volume of *We Were Never There*.

In this second volume, Wright sheds light on operational U-2 missions conducted over the Far East and East Asia from 1957-1974. This volume begins with early CIA U-2 operations looking at areas and installations of interest in the Soviet Far East. He also examines, in detail, U-2 operations over the Peoples Republic of China by Nationalist Chinese pilots in conjunction with the CIA. Additionally, the details of CIA and Taiwanese U-2 operations against the Yongbyon Nuclear reactor in North Korea are described. The book also looks at earlier CIA missions against Cuba during the Cuban Missile Crisis and the Bay of Pigs invasion.

Wright also discusses development of the U-2R. This was a complete redesign of the original aircraft and production of a new and larger U-2. The handling characteristics and comparisons between the older U-2C and the U-2R are discussed. There is even a portion devoted to equipping the U-2 for operations from US Navy aircraft carriers.

In the last section of this volume, Wright discusses the U-2 returning to Europe in the late 1960s. He also provides details of U-2 operations during the ceasefire between Israel, Egypt, and Syria in the early 1970s. Wright closes with the phasing out of the CIA's U-2 operations and summarizes the U-2's contribution to the world of intelligence collection.

Designed by Clarence "Kelly" Johnson of Lockheed's Skunk Works, the U-2 is perhaps the world's most famous "spy plane." First operated by the CIA, this aircraft flew at record-breaking altitudes above 70,000 feet, operated from undisclosed remote locations, did not have markings on the fuselage or tail, and took off and landed in the darkness under the utmost secrecy.

Overall, *We Were Never There Vol 2*, provides in-depth

---

detail about the early U-2, its missions in the Far East, and the aircraft's systems. Combined with the many maps and illustrations covering the period 1957-60, it will appeal to the U-2 or Cold War reconnaissance enthusiast. This volume is a great complement to Volume 1.

*Colonel Charles P "Chuck" Wilson, USAF (Ret); Chairman of The Cold War Museum; U-2 Pilot, Instructor Pilot, and unit commander; NASM docent*



**America's Few: Marine Aces of the South Pacific.** By Bill Yenne. Oxford UK: Osprey, 2022. Photographs. Illustrations. Appendix. Bibliography. Maps. Index. Pp. 352. \$35.00. ISBN: 978-1-4728-4749-2

This volume on double-digit Marine aces of World War II in the South Pacific is the latest book from prolific historian Bill Yenne, author of *Aces* (2020), *MacArthur's Air Force* (2019), and *Hap Arnold* (2013).

Yenne researched official histories, interviews, correspondence, war diaries, and combat reports to bring to life the combat experience of the Marine Wildcat and Corsair aces who scored ten or more victories in the particularly brutal air war over the Southwest Pacific, particularly Guadalcanal, Rabaul, and later the Philippines, Okinawa, and Japan itself. Until now Tillman's *Wildcat Aces* (1995), Musciano, *Bent Wing Bird* (1989) and Styling, *Corsair Aces* (1995), as well as the memoirs of the aces themselves—Joe Foss (1992) and Greg Boyington (1958) among them—have been the standard references for the study of Marine aces of the Southwest Pacific air war.

Yenne plumbs not just the ever-elusive quality of what makes an ace (a pilot with at least five victories) but a double-digit ace with ten or more kills. What sets a particular pilot apart from others that he scores not just five, but ten or more kills? The double digit aces this book focuses on are Joe Foss, John Smith, Joe Bauer, Marion Carl, James Swett, Greg Boyington, Manny Segal, and Bob Hanson. Yenne plumbs his subject's early lives, education, training, and personalities. Despite widely varying backgrounds, the aces shared certain characteristics that enabled them to surpass their peers. Being in the right place at the right time is part of it. Natural flying ability and an early interest in flying seem to be common attributes. Quick reflexes and an instinct for pursuit—the hunt—appear to be significant factors.

This book expertly assembles and renders a mass of often conflicting evidence to shed new light on oft-told air-combat stories. Yenne even-handedly discusses disputed claims, facts, and perspectives. The lively narrative vividly relates swirling dogfights that stretched from 30,000 feet to the wavetops. Strategies and tactics are described in laymen's terms. The day-to-day life of a squadron in combat is portrayed, enabling the reader to grasp the difficult con-

ditions under which these pilots labored. Accounts of their subsequent careers and lives round them out as people. Photographs include portraits of the aces, aircraft and air-field scenes, and medal ceremonies. Photos of air combat reports, along with deft analysis of their content, enable the reader to understand how victory claims are sorted out from the fog of war.

A list of the aces, their units, and kills would have been helpful. US Major General George Brett is identified as Australian. A little more on how the Marine air effort compared to that of the other services would have been welcome. However, these are minor points. This thoroughly researched, well-written book is the first time Marine aces are treated at length. It admirably achieves the difficult goal of being a fresh rendition of well-trodden ground. As air combat writing at its best, this book is highly recommended.

*Steven Agoratus, Hamilton NJ*



**Seven Seconds to Die: A Military Analysis of the Second Nagorno-Karabakh War and the Future of Warfighting.** By John Antal. Oxford UK: Casemate, 2022. Photographs. Illustrations. Diagrams. Maps. Notes. Index. Pp xvi, 179. \$22.95. ISBN: 978-1-63624-123-4

This book could not be timelier for understanding the battlespace in which the Russian invasion of Ukraine now takes place. We need only look at a brief conflict two years before.

On one level, this is about an obscure and very short war between Armenia and Azerbaijan in 2020—a traditional conflict fought between different ethnic groups to control commonly sought territory. In a greater context, however, Antal has provided a textbook examination of a conflict won by Azerbaijan's decisive use of state-of-the-art technology, including satellite imagery and an unmanned aerial vehicle system (UAS). UAS is the entire package of vehicles (UAV), the ground-control system, and the supporting network. Most importantly, the evolving concept of "all domain operations" (ADO), key to Azerbaijan's victory, has been demonstrated to be the future of conflict. ADO is the ability to integrate and effectively exercise command and control over all domains seamlessly. ADO uses global capabilities including space, cyber, electromagnetic spectrum operations, and command and control over all forces. To grasp what it means to not exercise ADO over the modern battlefield, one may look at the multiple failures of Russian forces in the Ukraine conflict. In contrast, Azerbaijan (trained, equipped, and advised by Turkey) employed satellite reconnaissance, unmanned platforms, information warfare, responsive command and control, and a strategy that maximized domination of the battlespace. In what Antal describes as the largest drone battle in his-



tory, Azerbaijan destroyed at least 1,021 Armenian military systems including air defense and electronic-war systems, tanks, artillery, and trucks. As a consequence, Armenia quickly sued for peace.

Antal informs the reader that with accelerated technological change and with the methods of war evolving rapidly, the battlefield can be commanded with a spectrum of surveillance systems integrated with unmanned and armed platforms loitering nearby, all connected into a network operating under real-time command and control. Hence the book's title: once detected, a soldier has just seven seconds to escape the kill zone or die.

In light of the increasing effectiveness of unmanned aerial systems (UAS), Antal emphasizes the urgent need to have a counter UAS (CUAS). To be effective, any system must have the capacity to defeat not only single drones but also drone swarm attacks. In response, the US has developed innovative anti-drone systems using high-energy lasers or high-powered microwave energy to defeat multiple UAVs. The highly effective September 2019 Iranian attack on Saudi oil production facilities using 20 UAVs and four cruise missiles demonstrated the failure to have a defensive system in place. The attack, in keeping with the ADO concept, was coupled with an equally important disinformation campaign to confuse the Saudis.

This study raises many questions about the nature of the emerging battlespace and how it is to be dominated. Tanks may no longer hold a central role, since they lack sophisticated methods of deception and masking. The large scale destruction of Russian armor in Ukraine makes that a valid concern. Antal has provided insights into how the battlespace will evolve into a fifth generation system.

To comprehend what is taking place in Ukraine and elsewhere and to anticipate how that will affect the future of warfare, it is essential to read Antal's highly informative guide.

*John Cirafici, Milford DE*



**CIA Station D: Area 51: The Complete Illustrated History of the CIA's Station D at Area 51.** By Thornton D. "TD" Barnes. Danbury CT: Begell House, 2021. Maps. Tables. Diagrams. Illustrations. Photographs. Notes. Appendices. Glossary. Bibliography. Index. Pp. 590. \$149.00. ISBN: 978-1-57600-492-2

TD Barnes provides the reader with a true Central Intelligence Agency (CIA) insider's story on nearly 30 years of CIA activities at the extremely sensitive location known as Area 51. He was a member of the special projects team at Area 51 for many of those years. This, along with his research of recently declassified secret documents, makes for a well-illustrated and comprehensive history of Area 51 during its early years.

CIA Station D-Area 51 was the most "secretive and power projection venue for testing secret, high-flying spy planes, developing stealth technology, conducting aerial reconnaissance, and exploiting acquired US adversaries' military assets." The book presents tremendous detail about the development, building, programs, and operation of the then-most-sensitive location in the US. Much of the information has not been revealed before.

Barnes outlines the astonishing array of names, nicknames, and code names used for the base since the CIA first chose it in 1955 as the perfect spot to secretly test fly the highly classified U-2 spy plane. He describes some of the challenges faced in detail, including the struggle between the USAF and CIA for aerial reconnaissance responsibility and its evolution into a tenuous partnership. Barnes describes the interagency challenges in aircraft selection, with Lockheed Skunkworks' U-2 being chosen.

A few years later, the CIA's high-flying, Mach-3+ A-12 was developed and flew at Area 51. The A-12 was the precursor to the SR-71 Blackbird (interestingly, the SR-71 did not test at Area-51, but out of Edwards AFB CA—in fact, the Air Force did not know about the A-12 until the SR-71 arrived at Kadena AB, Japan, to replace it). Additionally, the beginnings of the Navy Top Gun Weapons School and the Air Force Red Flag exercises also began in this area.

In addition to Soviet Union overflights, Barnes discusses creating and test flying U-2 operations in and around Japan, Turkey, China, and Europe, as well as 29 A-12 spy missions over Vietnam and North Korea. This is very revealing: the CIA worked Area 51 as a worldwide spying operation.

As time went on, Area 51 work increased with multiple Special Projects unfolding, each with its own "need to know." Along the way, there were many, many challenges, sacrifices, and accomplishments by all who served at Area 51. These helped make both the CIA and US the world leader in science and technology.

Barnes also covers the pilots and aircrews who lost their lives. He discusses the thousands of Americans who help launch the CIA into the world of overhead reconnaissance. It has been said, "these Americans whose patriotism, ingenuity, and willingness to take on projects considered impossible back then allowed the U.S. to penetrate the Iron Curtain and win the Cold War."

In all, Barnes' book is the most comprehensive, illustrated, go-to reference book on the early years of Area 51. I highly recommend it for your reference library.

*Colonel Charles P "Chuck" Wilson, USAF (Ret); Chairman of the Board, The Cold War Museum®; U-2 pilot and commander; NASM docent*



**Going Downtown: The US Air Force Over Vietnam, Laos and Cambodia, 1961-75.** By Thomas McKelvey

---

Cleaver. Oxford UK. Osprey, 2022. Bibliography. Glossary. Index. Maps. Photographs. Pp. 369. \$30.00. ISBN 978-1-47284-876-5

Cleaver has been a writer for 40 years, with a number of Osprey titles to his credit. He has been a screenwriter in Hollywood, worked as a supervising producer on several TV and cable series, and served in the US Navy in Vietnam.

During the period between the early 1950s and the late 1970s, the US was engaged in wars in Korea, Vietnam, Laos and Cambodia. At the end of French colonial rule in Vietnam, a treaty signed in July 1954 in Geneva split Vietnam into North and South along the 17th Parallel, with the Viet Minh in control in the North, and the anti-communist government of the Republic of Vietnam in the South. It was not long before North Vietnamese forces began to infiltrate both South Vietnam and Laos. Thus, in the early 1960s, began the decade-long US involvement in Vietnam and, later, in Laos and Cambodia. This began with advisory services but steadily escalated into deployment of US military ground troops and air forces.

Cleaver presents a year-by-year account of the ever-increasing US military involvement from the US Air Force point of view. As a follow-on to *The Tonkin Gulf Yacht Club*, his telling of the story of the US Navy's involvement in the Vietnam War, *Going Downtown* completes the picture. It is a thorough, albeit depressing, story relating US political incompetence, military unpreparedness, and outmoded strategy and tactics opposing a resolute, well-supported enemy. These were factors which the bravery and inventiveness of our inadequately trained aircrews could not easily overcome!

The book begins with a quick vignette about a burning AT-28D over the Ho Chi Minh trail at night! Cleaver builds interest in later chapters relating different aircraft and tactics for ground attack and air-to-air combat. He moves on to explain how the conflagration got started with "good intentions and ignorance." He follows with "planning for the wrong war"—relating the USAF's fixation on nuclear war without remembering the lessons gained in Korea. This resulted in the wrong equipment and the wrong training. Cleaver then uses vignettes, integrated with pilot and crew accounts, about actual air-to-air and air-to-ground combat. This paints a picture of how the air war in Vietnam slowly evolved. He details various missions and describes aircraft, airbases, and aircrews on both sides of the conflict. He portrays air campaigns including "Rolling Thunder," "Linebacker," the "Easter Offensive," and "Christmas Bombing." Cleaver also illustrates the difficulties encountered against major targets in the North. The reader is left with an impressive picture of what air combat is really like. Cleaver also describes similar air combat actions that occurred in Laos and Cambodia after the Paris Peace Accords were signed. Those effectively ended US involvement in Vietnam itself.

This is a well-researched account of the Vietnam conflict and secret Laotian and Cambodian air wars. Cleaver provides many combat mission-oriented vignettes which allow the reader to become well informed about the aircraft, ordinance, and personnel involved. It is an excellent resource for enthusiasts of air combat tactics, aircraft performance, and aircrew capabilities.

*Frank Willingham, NASM docent*



**"Big Week" 1944: Operation Argument and the Breaking of the Jagdwaffe.** By Douglas C. Dildy. Oxford UK: Osprey, 2022. Photographs. Maps. Diagrams. Tables. Pp. 96. \$24.00 paperback. ISBN: 978-1-4728-2451-6

One of the most studied aspects of the air war over Europe in World War II is the intense, no-holds barred Allied aerial campaign against Nazi Germany, code-named ARGUMENT, intended to wrest control of the skies from the Luftwaffe to enable Operation OVERLORD, the planned invasion of Northern Europe, to succeed. In a series of concentrated attacks in February 1944, US heavy bombers struck targets critical to enemy airpower such as airframe, component, and engine factories. The prime purpose of these missions, however, was to draw out enemy fighters to be shot down by US long-range escort fighters. The ensuing attrition of the Luftwaffe's fighter force, especially experienced pilots, enabled Allied air superiority over Europe in time for OVERLORD.

Originally planned for 1943, bad weather delayed the campaign until the third week of February 1944. With a few days of clear skies over the targets in the forecast, US Eighth and Fifteenth Air Force bombers, flying almost every day, fanned out over Germany. The Luftwaffe's well-organized defensive system sent up fighters to intercept. US P-47s, P-38s, and P-51s engaged them. Dubbed Big Week due not only to the scale and scope of the intense combat that resulted, but also to the degree of success, this operation cost the Luftwaffe a critical number of hard-to-replace veteran pilots. Allied aerial commanders continued the attrition of the Luftwaffe with a concentrated series of attacks on Berlin in the first week of March.

This epic battle has become a frequently studied topic, with many works, starting with Glenn Infield (1974) dissecting the successes and failures on both sides. Recent volumes by Keeney (2012), Hammel (2009), Holland (2018) and Yenne (2012) point to continued interest in this subject. A retired USAF Colonel and 32nd FS commander, F-15 pilot Douglas Dildy's previous Osprey titles include *Dambusters* (2010), *Battle of Britain* (2018) and *Dunkirk* (2010).

Dildy researched both the Allied and enemy sides to give a comprehensive account of the biggest aerial combat campaign in history. His accounts of Big Week planning,



combat, and costs-versus-benefits have the ring of an experienced operational leader. There are no footnotes, but Dildy cites his sources in the text, especially the works of Donald Caldwell, the dean of Luftwaffe fighter force historiography. Graham Turner's skillful illustrations depict key moments in dogfights. Numerous charts, graphs, and mission plots of heavy Big Week air combat enhance the effect of being in a post-mission debriefing. Among the many photos familiar to me are several new ones of both allied and enemy combatants and leaders, along with brief biographical sketches.

It is a measure of the value of Dildy's writing that Osprey packed in five hundred words per page to meet their usual 96-page limit. The result is a little hard on the eyes, but this distinctive retelling should become a standard reference on Big Week. For those looking for a work that brings home the desperate, high-stakes, deadly battles over Europe in 1944, this book is highly recommended.

*Steven Agoratus, Hamilton NJ*



**Escape from Java: The Extraordinary World War II Story of the U.S.S. Marblehead.** By John J. Domagalski. Philadelphia: Pen & Sword Books, 2022. Maps. Photographs. Notes. Index. Pp. ix, 310. \$34.95. ISBN: 978-1-52678-441-4

This book is the fifth produced by Domagalski emphasizing US Naval operations in the southwestern Pacific. His previous works examined the role of patrol-torpedo boats and the sinkings of several different American warships. Intrigued with naval warfare since childhood, Domagalski had the foresight to interview many survivors about their combat experiences. Thus he has blended these reminiscences from many now-deceased veterans with the official record and secondary sources.

He uses the *Marblehead*'s voyage to set up other stories: the relentless Japanese expansion into the Dutch East Indies; the complex issues of coalition warfare confronting the American, British, Dutch and Australian commanders; and the heroic effort of a US Navy physician, Dr. Corydon Wassell.

The *Marblehead*, a light cruiser launched in 1923, was one of the more prominent components of the Navy's Asiatic Fleet. On December 8, 1941 (December 7 in Hawaii) when the Japanese attacked the Philippine Islands, the Asiatic Fleet called Manila its home, though its assets were scattered throughout the region.

The vigorous Japanese advance forced the Asiatic Fleet out of the Philippines southward where the Allies hoped to defend the resource-rich East Indies archipelago as long as possible. With little opposition, Japanese land forces quickly captured critical air bases, thus aiding their advance. Japanese air power controlled the skies, stalking

Allied vessels at every opportunity. On February 4, 1942, the *Marblehead* nearly succumbed to Japanese bombers in the Java Sea. Only an exceptional demonstration of damage control allowed the ship to escape. Ultimately, its crew would complete sufficient repairs that enabled the *Marblehead* to reach port on the south side of Java. From there, the ship proceeded west to the Indian Ocean, around South Africa and eventually to New York City May 4, 1942. For many, the *Marblehead*'s arrival was somewhat surprising, since the Japanese had publicly acknowledged sinking the ship.

The crew experienced significant casualties from the attack. Those suffering from the most serious injuries were left in Java. Among them was the ship's executive officer who recalled his miraculous escape in considerable detail. Dr. Wassell somehow found the means to transport the injured from the *Marblehead* and elsewhere across Java to a southern port. From there, they boarded one of the last vessels leaving the island ahead of the Japanese. A few days later, the ship arrived in Australia. On board were several reporters, one of whom published a book about Wassell's efforts. In 1944, American moviegoers could view *The Story of Dr. Wassell*, starring Gary Cooper in the title role.

This work emphasizes the impact of land-based air power affecting naval operations. It is recommended for anyone interested in the early days of World War II in the southwest Pacific, the challenges of coalition warfare, or both.

*Steven D. Ellis, Lt Col, USAFR (Ret), docent, Museum of Flight, Seattle WA*



**Red Star Versus Rising Sun Volume 2: The Nomonhan Incident 1939.** By Adrien Fontanellaz. Warwick UK: Helion and Company. 2022. Photographs. Illustrations. Notes. Maps. Pp. 72. \$29.95 paperback. ISBN: 978-191162866-8

The early twentieth century saw the collision of two empires in Asia: a transforming Russian Empire, and a Japanese empire looking outward for the first time in modern history. The first clash of these empires took the form of the 1905 Russo-Japanese War, a resounding victory for Japan and the first death knell of the Romanov's imperial throne. Some armchair historians will also remember that the United States gained stature by bringing an end to the conflict and earning Teddy Roosevelt a Noble Peace Prize. Thirty-five years later the Japanese Empire was expanding by seizing control of key Chinese regions on the Russian Border—areas that the Soviet Russian Empire coveted for Rodina.

In this volume of Helion's Asia @ War series, Fontanellaz provides a detailed account of the 129-day Nomonhan Incident, also known as the Battles of Khalkhin Gol. It

---

should be noted that, while this was a clash of empires, the nation-state combatants were Russia, Japan, Mongolia, and Manchuria. This conflict occurred immediately before the eruption of World War II in Europe.

The book walks that fine line between an illustration-heavy work targeting the modeler market and a detail-heavy synopsis with copious notes and citations and does so successfully. That is no mean feat given the difficulty in reading the text, which uses foreign words and names copiously throughout. Many locations carry the Russian, Japanese, and Chinese names. Military formations also carry a variety of names and numbers that are not always intuitive. The book is not an easy, recreational read.

Fontanellaz clearly describes the outcome of the Incident and how exactly the results came about. He shows how the Incident contained numerous military firsts: first use of large size aerial bombardment formations; first use of large, armored vehicle formations; and the importance of adequate anti-tank weapons at all levels of engagement. He also credits much Russian success to a new commander named Georgy Zhukov. Zhukov used his opportunity to gain Stalin's trust. That trust would prove invaluable when Russia began its counter-offensive to expel German occupation and follow them back to the Fatherland. And he shows that many of the problems encountered by the Japanese Army were self-inflicted, that these problems were not addressed, and that they would still be a factor when the Russian Army attacked Japanese forces in Manchuria in 1945.

I find Helion products to be entertaining and educational. Their authors do a good job bringing niche historical events to the fore and explaining how they influenced future events. They find interesting and appropriate photographs and illustrations to advance their narrative. On the downside, the narrative can be a tough read. In this case, however, the subject was of sufficient interest that it encourages the reader to complete the book.

*Gary Connor, Docent, Smithsonian National Air and Space Museum's Udvar-Hazy Center*



**Operation Vengeance: The Astonishing Aerial Ambush That Changed World War II.** By Dan Hampton. New York: Ascalon, 2020. Photographs. Maps. Bibliography. Notes. Index. Pp. 430. \$28.99 paperback. ISBN: 978-0-06-293809-1

The first 18 months of America's direct involvement in World War II were the darkest of the war. The Axis powers advanced on all fronts; losses piled up; and morale was at its lowest. Yet it was during this time that leaders took inspiration from George Danton's famous quote, "*De l'audace, encore de l'audace, toujours de l'audace.*" The Doolittle Raid, Midway, Guadalcanal, and the Yamamoto shootdown were

examples of America risking all to stun its enemies, seize momentum, and change the course of the war. Not all commanders accepted the risk, but those that did were rewarded with a place in America's pantheon of heroes.

Hampton tells the story of the mission that ended the life of the Japan's most recognized and successful leader, but also gives a detailed short course on the Pacific War leading up to April 18, 1943. He describes key combatants on both sides and their successes and failures. The resulting portraits demonstrate their humanity and fallibility. In doing so, Hampton abandons any neutral or academically balanced role. He does not hesitate to use harsh adjectives to describe many senior US and Japanese leaders. But he saves his harshest words for one US pilot.

While the mission to shoot down Yamamoto was successful, there has been an ongoing controversy over which pilot should have rightly received aerial-victory credit. Historians are divided between awarding credit to Lt Tom Lanphier, leader of the "kill" flight, and Lt Rex Barber, number four in the same flight. Lanphier came from a distinguished family with a strong record of military service and made no secret of his post-war political ambitions and how receiving credit for Yamamoto's death could support his ambitions. Barber, on the other hand, came from a humble background. Lanphier's official report awarded full victory credit to himself. He even broadcast his success over open radio channels and to the press. While the mission's US Navy chain-of-command considered Medals of Honor for mission personnel, Admiral Halsey downgraded the award to Navy Crosses and sent Lanphier and Barber into exile in bureaucratic assignments.

From 1943 until the early 1990s, the issue simmered. USAF boards evaluated evidence that seemed to invalidate Lanphier's claim while substantiating Barber's. Officially, victory credit is shared by both airmen. Hampton does not subscribe to such half measures. He is clearly in Barber's camp, takes every opportunity to vilify Lanphier, abandons any premise of neutrality, and offers this book to "set the record straight."

I like factual and well-documented history where I can make up my own mind. In the case of Operation Vengeance, the preponderance of evidence supports Barber's success. The evidence Hampton offers indicated Lanphier acted badly and exploited his position in a self-serving manner. But Lanphier flew that mission and faced the same dangers and challenges as the other pilots. He sat for hours in a broiling cockpit smelling of fuel, hydraulics, and urine just as every other pilot did. And he faced the same enemy. He is buried in Arlington National Cemetery along with other servicemen whose character did not receive the microscopic dissection that Hampton offered.

Overall, this is not a bad book, although there are some editorial glitches and basic spelling errors. The book is strongest when Hampton puts the reader in the cockpit of a P-38. I have no issue with his taking sides. I do have an



issue with the way he does it.

*Gary Connor, docent, Smithsonian National Air and Space Museum's Udvar Hazy Center*



**The Role of Intelligence in the Battle of Britain.** By Norman Ridley. South Yorkshire UK. Air World, 2021. Maps. Photographs. Appendices. Bibliography. Notes. Index. Pp. vii, 263. \$49.95. ISBN 978-1-39901-038-2.

In this book, Norman Ridley explores how the Royal Air Force and the Luftwaffe employed intelligence during the Battle of Britain and the extent to which intelligence helped or hindered the conduct of their respective operations. He concludes that the RAF was more successful in the application of intelligence, principally the tactical intelligence that radar provided Air Marshal Hugh Dowding's command-and-control system. Radar enabled the RAF to more efficiently allocate Fighter Command's resources to counter Luftwaffe attacks. In contrast, the focus of intelligence in the Luftwaffe was more strategic than tactical. It hindered Luftwaffe operations by continuously overestimating RAF losses and the results of Luftwaffe bombing. Throughout the Battle, Luftwaffe intelligence failed to understand Fighter Command's command-and-control system.

Ridley examines the organizational structure of intelligence gathering in the Luftwaffe and the RAF, contrasting the approaches and methods of intelligence gathering, and the attitudes towards the importance of intelligence. He frames the intelligence effort as having three requirements: acquisition of information, interpretation of information, and efficient application of conclusions drawn from the information gathered. In contrast to the more-open debate within the RAF on intelligence, he argues that the Luftwaffe's intelligence organizations were more subject to political influence and the pressure to have conclusions conform to expectations—not necessarily reality. He uses chapters on the development of radar in the Luftwaffe and the RAF to explain why the Luftwaffe underestimated the importance of radar as a defensive system. The role of intelligence in RAF Fighter Command and the Luftwaffe differed markedly, with Fighter Command having to respond to daily Luftwaffe attacks and the Luftwaffe having to use intelligence to make strategic and operational decisions.

As an introduction to the topic of intelligence in the Battle of Britain, Ridley's book has some merit but it is not without drawbacks. The main difficulty with the book is its reliance on a limited number of primarily secondary sources. The book provides no new interpretations. The information and conclusions have appeared in other studies of the battle. In many ways the book is simply a summary of what has already been written. There is no evidence in the sources or the notes that Ridley explored the records

of the RAF's Air Intelligence Branch, Fighter Command, or the Cabinet that might have provided fresh insights. One would think that with all the histories of the Battle of Britain available, seeking out new information might have been worth the effort. The book would also have benefited from more-focused editing. The chapters on the British development of radar and the Dowding system simply repeat what has appeared in other histories, while chapters on the Enigma machine and the Polish code breakers are tangential to the battle itself. A chapter on the Tizard Mission to America, which took place after the Battle, is irrelevant. Readers new to the history of the Battle of Britain might be better off starting with some of the more comprehensive studies that have appeared.

*Edward Young, PhD, Volunteer, Museum of Flight, Seattle WA.*



**The Men Who Gave Us Wings: Britain & The Aeroplane 1796-1914.** By Peter Reese. Barnsley UK: Pen & Sword Aviation, 2020. Photographs. Notes. Appendices. Bibliography. Index. Pp. 252. \$12.57 paperback. ISBN: 978-1-52678-195-6

Peter Reese has written several aviation histories and non-aviation biographies. In this book, he explains why Britain fell far behind other European nations in the race to develop airplanes in the late 19th and early 20th centuries. It was surprising that Britain would lag behind. At the time it was the world's preeminent nation in matters of science and technology. The UK (along with every other nation in the world) was beaten by the Wrights in developing the first successful flying machine and were then beaten by the French and the Germans in the broader development of the airplane. Reese provides a lot of 19th-century history of British aviation experimentation, but his primary focus is on the key period leading up to World War I, when a remarkable group of individuals drove the nation forward against formidable difficulties.

Noteworthy accomplishments before 1900 include those of Sir George Cayley and Francis Wenham. Cayley was the first person to identify the key components of an aircraft: lift, propulsion, and control. Wenham is credited with the invention of the wind tunnel, which was further developed by others and now is an essential element in the aeronautical-design process. On the downside, despite the best efforts of Cayley and others, British aviation in the 19th century was characterized by aircraft experimenters not sharing their findings and failing to learn from the successes and failures of their predecessors and contemporaries, and by a government that was slow to recognize and capitalize on the airplane as a military instrument. It was the latter factor that best explains why Britain lagged behind other nations in aircraft development.

As Europe moved closer to war, British designers and pilots began to extend the capabilities of their aircraft. In addition to the well-known individuals such as Tommy Sopwith and the Short brothers, two men are worthy of mention. Gustav Hamel was something of a showman in the air, but he concentrated on practical matters such as high-speed flight and the ability to operate effectively in bad weather. And Edward Busk was both a designer and a pilot. He pushed his craft to the limits of their performance and, at the same time, led a team that successfully developed flight instruments to make the pilot's job easier. Hamel, Busk, and many others contributed to an aviation community that, after a slow start, produced some of the most capable aircraft of the war.

I have one small criticism. Reese frequently discusses how large some investment was or how much a designer wanted for his airplane. His figures are in British pounds, but most of us can handle the conversion across currencies. The problem is that his numbers are all in then-year values, with no adjustments for price growth. These money references are important, but without a current frame of reference, the message is lost on the reader. Despite this, Reese can be commended for giving us a straightforward, factual account of his subject. The book is well worth the time for someone interested in the questions he raises.

*Lt Col Joseph Romito, USA (Ret), docent, National Air and Space Museum*



**Finnish Aces: Their Planes and Units 1939-1945.** By Kari Stenman and Karolina Holda. Sandomierz, Poland: Stratus, 2022. Map. Tables. Illustrations. Glossary. Photographs. Appendices. Bibliography. Index. Pp. 432. \$75.00. ISBN: 978-83-66549-59-3

The first thing that needs to be said about this book is that it is one fantastic piece of research. The authors put over 50 years into collecting material, and their work resulted in superb coverage of a little-discussed aspect of World War II.

The Winter War and Continuation War were virtually one long conflict between the Soviet Union and Finland from November 1939-September 1944. I would bet that few people are familiar with the wars and the fact that there was a huge amount of air-to-air combat.

In their introduction, the authors provide one of the finest treatises I've read on air victories and the problems associated with victory counts. This pertains to any air war since the invention of the airplane. From there, the book has three distinct parts.

The first is alphabetically organized and covers each of the 100 Finnish aces of the period (a high percentage of whom were enlisted or warrant-officer pilots). Finland's leading ace, Warrant Officer Juutilainen, had 94 victories.

Each entry has a short bio; the aircraft flown along with pics and, often, illustrations; and a table of each victory with date, location, the victim's aircraft and unit; and type of victory (confirmed, probable or damaged). This is not a casual-read section. The 198 pages are encyclopedic in nature.

The second, 168-page section is in narrative form and covers each of the eight fighter squadrons that fought the Red Air Force. This contains the details of the air war. It is primarily written in chronological format and covers the aircraft used, tactics employed, the combat situation, and the air engagements (often in first-person accounts).

The third section takes up 50 pages and is comprised of 23 appendices. These cover a victory-ordered list of the aces, foreign pilots (Swedes and Danes) who flew with the Finns, destroyed observation balloons, victory and unit markings, unit commanders, and more. They are, again, encyclopedic in nature. The book finishes with an excellent index and bibliography.

The Finnish Air Force ran up 1621 victories (and these were verified by years of checking Finnish and Soviet combat reports and related documents and compiled using the same rules the US and UK used in their evaluations of air victories). The airplanes used were a fascinating hodgepodge of types from a number of different countries: Fokker D.XXI (NL), Messerschmitt Bf 109 (GE), Curtiss Hawk (P-36) and Brewster Buffalo (US), Polikarpov I-153 and Lavochkin LaGG-3 (captured USSR), Fiat G.50 (IT), Morane-Saulnier MS.406 and Caudron Renault CR.714 (FR), Gloster Gladiator and Hawker Hurricane (UK), and VL Myrsky models (Finn). The Finns took on one of the largest militaries in the world and held their own, despite the odds.

The photos and illustrations are excellent. Layout and quality are superb. The research is impeccable. The occasional typo disappears in the noise. This is THE book to read for those interested in an intense but relatively unknown air war of the period.

*Col Scott A. Willey, USAF (Ret), Book Review Editor, and former National Air and Space Museum docent*



**The Oil Campaign 1944-1945: Draining the Wehrmacht's lifeblood.** By Steven J. Zaloga. New York: Osprey Publishing, 2022. Tables. Maps. Photographs. Illustrations. Notes. Bibliography. Index. Pp. 96. \$24.00 paperback. ISBN: 978-1-4728-4854-3

Zaloga is best known as a prolific writer in the field of armor combat and technology. In recent years, he has spread his wings, contributing various works to Osprey's multiple series on military aviation. This book is in Osprey's Air Campaign series.

As with other Osprey series, books in this category follow the same outline with tables, maps, illustrations, and photographs complementing the narrative.



The introduction provides the foundation for what follows by briefly reviewing past targeting initiatives by the Royal Air Force and the US Army Air Forces. American Lt Gen Carl Spaatz is generally credited with most vigorously advocating a sustained aerial assault on Germany's synthetic oil production. What turned out to be the Allies' most effective bombing strategy followed several other efforts. Among these were establishing air supremacy and disrupting transportation networks to help ensure the success of the invasion of France. Meanwhile, RAF Bomber Command's Air Marshall Arthur Harris continued to pursue crushing morale by obliterating enemy cities.

The following two chapters discuss the attackers' and defenders' capabilities, respectively. While relatively brief, each chapter examines how the adversaries' operations and tactics had evolved up to May 1944 when oil plants were attacked for the first time. Electronic warfare receives considerable attention. Both sides deployed technical advances that required countermoves to thwart their effectiveness.

About half of the book examines the various missions from 1944 to the spring of 1945. The missions are broken down by month. Typically, a mission summary mentions bombing effectiveness and aircraft losses/claim for both sides. Tables summarize bomb tonnage; German fighters available at various stages; sorties by US Eighth and Fifteenth Air Forces and RAF Bomber Command; and, most importantly, the decline in oil production. Whereas the Allies' success ultimately resulted because of superior personnel and aircraft quantity, the Germans experienced a downward spiral. Reduction in oil hampered pilot training. The technically superior Messerschmitt Me 262 jet appeared too late and in too few numbers to change the out-

come. The book concludes with a brief analysis that nicely summarizes many of the points previously introduced.

Unfortunately, Osprey's format precludes the use of citations with one exception—references to other Osprey publications. In this work, there were many instances when I wished to know Zaloga's source. The bibliography lists the standard works relating to the CBO. Of the more than 50 listed, only four have been published in the past 10 years. One nit to pick is the vagueness concerning aircraft losses versus claims. In some instances, it is clear the numbers cited refer to losses, the most reliable measure. Elsewhere, however, claims are used. Claims, of course, were highly exaggerated. Despite this, the work is highly recommended for anyone unfamiliar with this aspect of the Combined Bomber Offensive (CBO).

*Steven D. Ellis, Lt Col, USAFR (Ret), docent, Museum of Flight, Seattle WA*



#### PROSPECTIVE REVIEWERS

Anyone who believes he or she is qualified to substantively assess books for the journal should contact our Book Review Editor for a list of books available and instructions. The Editor can be contacted at:

Col. Scott A. Willey, USAF (Ret.)  
46994 Eaker St  
Potomac Falls VA 20165  
Tel. (703) 409-3381  
e-mail: [scottlin.willey@gmail.com](mailto:scottlin.willey@gmail.com)

**Guidelines for Contributors**—We seek quality articles—based on sound scholarship, perceptive analysis, and/or firsthand experience—which are well-written and attractively illustrated. If a manuscript is under consideration by another publication, the author should clearly indicate this at the time of submission. Manuscripts should be prepared according to the Chicago Manual of Style (University of Chicago Press). Use civilian dates (month, day, year) and either footnotes or endnotes may be used. Because submissions are evaluated anonymously, the author's name should appear only on the title page. Authors should provide on a separate page brief biographical details, to include institutional or professional affiliation and recent publications, for inclusion in the printed article. Pages, including those containing illustrations, diagrams or tables, should be numbered consecutively. Any figures and tables must be clearly produced ready for photographic reproduction. The source should be given below the table. Notes should be numbered consecutively through the article with a raised numeral corresponding to the list of notes placed at the end. Submissions may be submitted either by mail or via email. Email is generally the norm. While Microsoft Word is the most common, any word processor may be used. Do not "Track Changes." Photographic illustrations are greatly appreciated. There is no restriction on the file format used. There is no standard length for articles, but 4,500-5,500 words is a general guide. Manuscripts and editorial correspondence should be sent to Richard Wolf, Editor, c/o Air Power History, 70 Shannon Way, Upton, MA 01568, e-mail: [airpowerhistory@yahoo.com](mailto:airpowerhistory@yahoo.com).

# Coming Up



## September 8-10, 2022

The **Tailhook Association** will hold its annual gathering at the Nugget Casino Resort Hotel in Sparks/Reno, Nevada. The theme of this year's presentation is "Celebrating 100 Years of U.S. Navy Aircraft Carriers." For reservations and other details, see the Association's website at [www.tailhook.net](http://www.tailhook.net).

## September 16-17, 2022

The **National Museum of the Pacific War** will hold its Nimitz Foundation Symposium at the Nimitz Hotel in Fredericksburg, Texas. The theme of this year's symposium is "1942: The Perilous Year." For registration, see the Museum's website at <https://www.pacificwarmuseum.org/education/museum-programs/symposium>

## September 17-18, 2022

The **Air Force Association** will hold its annual meeting and convention at the Gaylord National Resort in National Harbor, Maryland. For registration and schedule particulars, see the Association's website at 2022 National Convention ([afa.org](http://afa.org)).

## September 21-24, 2022

The **Society of Experimental Test Pilots** will hold its 66th annual symposium and banquet at the Grand Californian Hotel in Anaheim, California. For details, see the Society's website at <https://www.setp.org/symposium/meetings/annual-symposium-banquet/>.

## September 24, 2022

The **National Aviation Hall of Fame** will hold its 59th annual dinner and enshrinement ceremony to honor the Class of 2022's nominees. This event will be held in conjunction with the Wright State University's 2022 Festival of Flight to be held in Dayton, Ohio. For more information see the NAHF's website at National Aviation Hall of Fame.

## September 25-26, 2022

The **International Committee for the History of Technology** will present the second portion of its annual symposium in virtual form; the third session will be held on October 15-16. For details and registration, see the Committee's website at [ICOHTEC 2022 \(osu.edu\)](http://ICOHTEC2022.osu.edu).

## October 10-12, 2022

The **Association of the United States Army** will offer its annual meeting and exposition at the Walter E. Washington Convention Center in Washington, D.C. Download a prospectus from the Association's website at Home ([ausa.org](http://ausa.org)).

## October 19-22, 2022

The **Oral History Association** will hold its annual meeting at the Millennium Biltmore Hotel in Los Angeles, California. The theme of this year's meeting is "Walking Through the Fire: Human Perseverance in Times of Turmoil." For registration and more information, see the Association's website at <https://www.oralhistory.org/2022-call-for-proposals/>

## October 20-23, 2022

The **Mars Society** will hold its 25th Annual Convention at Arizona State University in Tempe, Arizona. The theme of this year's gathering is "Searching for Life with Heavy Lift." For registration, see the Society's website at The Mars Society.

## October 25-27, 2022

The **Association of Old Crows** will offer its 59th annual international symposium and convention in Washington, D.C. For more details as they become available, ping a Crow at [AOC Annual Symposium \(crows.org\)](http://AOCAnnualSymposium(crows.org)).

## October 26-28, 2022

The **American Astronautical Society** will host its annual Wernher von Braun Memorial Symposium at the University of Alabama in Huntsville at Huntsville, Alabama. For registration and other details, see the Society's website at <https://astronautical.org/events/vonbraun/>

## October 27-30, 2022

The **American Fighter Aces Association** will host its 2022 Reunion at the Drury Plaza Hotel in San Antonio, Texas. To register or obtain more details, see the Association's website at <https://www.americanfighteraces.org/events/?v=d43cf049304b>

## November 4-5, 2022

The **National World War I Museum and Memorial** will hold its annual symposium at the Museum in Kansas City,

Compiled by  
George W. Cully

In light of the coronavirus pandemic, events listed here may not happen on the dates listed here, or at all. Be sure to check the schedules listed on the individual organization's web sites for the latest information.

Kansas. The theme of this year's gathering is "Shifting Tides: Citizenship in a World of Conflict." For more information, see the Museum's website at Symposia | National WWI Museum and Memorial ([theworldwar.org](http://theworldwar.org)).

## November 10-13, 2022

The **Society for the History of Technology** will hold its annual meeting in New Orleans, Louisiana. For specifics as they become announced, see the Society's website at 2022 SHOT Annual Meeting, 7-13 November, New Orleans (Louisiana) – Society for the History of Technology (SHOT).

## November 17-19, 2020

The **National WWII Museum** will host its 15th annual International Conference on WWII at the Higgins Hotel & Conference Center in New Orleans, Louisiana. The theme of this year's conference is "Resistance! Life Under Occupation." For registration and program details, see the Museum's website at <https://www.nationalww2museum.org/events-programs/events/130537-15th-international-conference-world-war-ii>

## November 17-20, 2022

The **History of Science Society** will hold its annual meeting in Chicago, Illinois. For specifics when they are determined, see the Society's website at <https://hssonline.org/page/hss22>.

## January 5-8, 2023

The **American Historical Society** will hold its 136th annual meeting at the Philadelphia Marriott Downtown in Philadelphia, PA. Details remain to be determined; see the Society's website at <https://www.historians.org/annual-meeting/future-meetings>.

Readers are invited to submit listings of upcoming events. Please include the name of the organization, title of the event, dates and location of where it will be held, as well as contact information. Send listings to:

George W. Cully  
3300 Evergreen Hill  
Montgomery, AL 36106  
(334) 277-2165  
E-mail: [warty0001@gmail.com](mailto:warty0001@gmail.com)



# History Mystery Answer

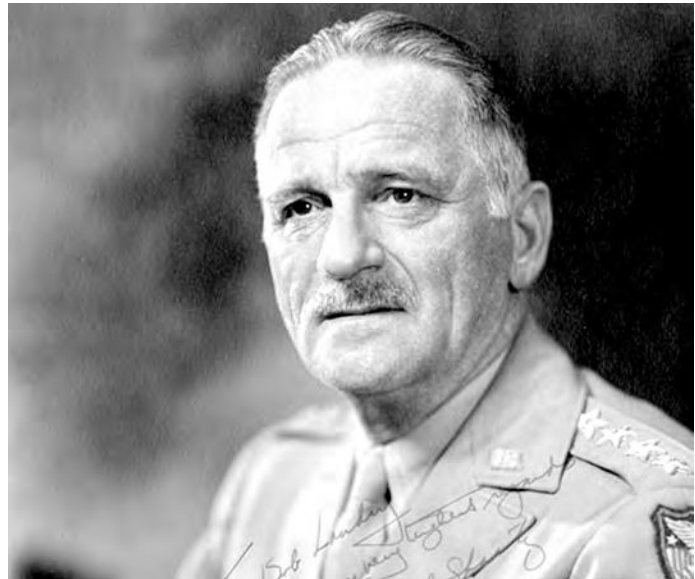

This edition's Air Force legend is General Carl A. "Tooe" Spaatz. Born in 1891, Carl Spaatz graduated from West Point as part of the class of 1914. During his time at there, he got the nickname "Tooe," because he looked similar to a cadet of that name. After first being an infantry officer, Spaatz transferred to the Aviation School. During World War I, Spaatz commanded the 31st Aero Squadron (today the squadron is the 31st Test and Evaluation Squadron). In 1923, Major Spaatz was a pilot for the airplane "Question Mark." Spatz (the general would later change the spelling of his last name to Spaatz) and crew flew for over six days through refueling via hose lowered from refueling airplanes. The test proved the feasibility of global reach via aerial refueling. In 1942, he became Eighth Air Force commander. In 1944, Gen Spaatz received the Collier Trophy for "demonstrating the air power concept through employment of American aviation in the war against Germany," and went on to hold increasing levels of responsibility during World War II. He was present at all three unconditional surrender ceremonies: Rheims, Berlin, and Tokyo. Finally, on September 26th 1947, he became the first Chief of Staff of the Air Force. After

forty-four years of service, General Carl A. "Tooe" Spaatz finally retired from the military in 1948.

To learn more about:

**Carl Spaatz:** <https://www.af.mil/About-Us/Biographies/Display/Article/105528/general-carl-a-spaatz/>

**Spaatz and the Question Mark:** <https://www.national-museum.af.mil/Visit/Museum-Exhibits/Fact-Sheets/Display/Article/197384/flight-of-the-question-mark/>  
<https://www.af.mil/News/Features/Display/Article/143226/light-of-the-question-mark/>

**The History of Aerial Refueling:** *Seventy-Five Years of Aerial Refueling.* <https://media.defense.gov/2010/Sep/29/2001329785/-1/-1/0/75%20years%20red.pdf>

**Carl Spaatz during World War II** *Carl A. Spaatz and the Air War in Europe* <https://ia804509.us.archive.org/30/items/CarlASpaatzAndTheAirWarInEurope/CarlASpaatzAndTheAirWarInEurope.pdf>

**Establishing the AF:** *Planning and organizing the postwar Air Force: 1943-1947* [https://media.defense.gov/2010/Sep/28/2001329803/-1/-1/0/planning\\_and\\_organizing\\_the\\_postwar\\_afpdf](https://media.defense.gov/2010/Sep/28/2001329803/-1/-1/0/planning_and_organizing_the_postwar_afpdf)

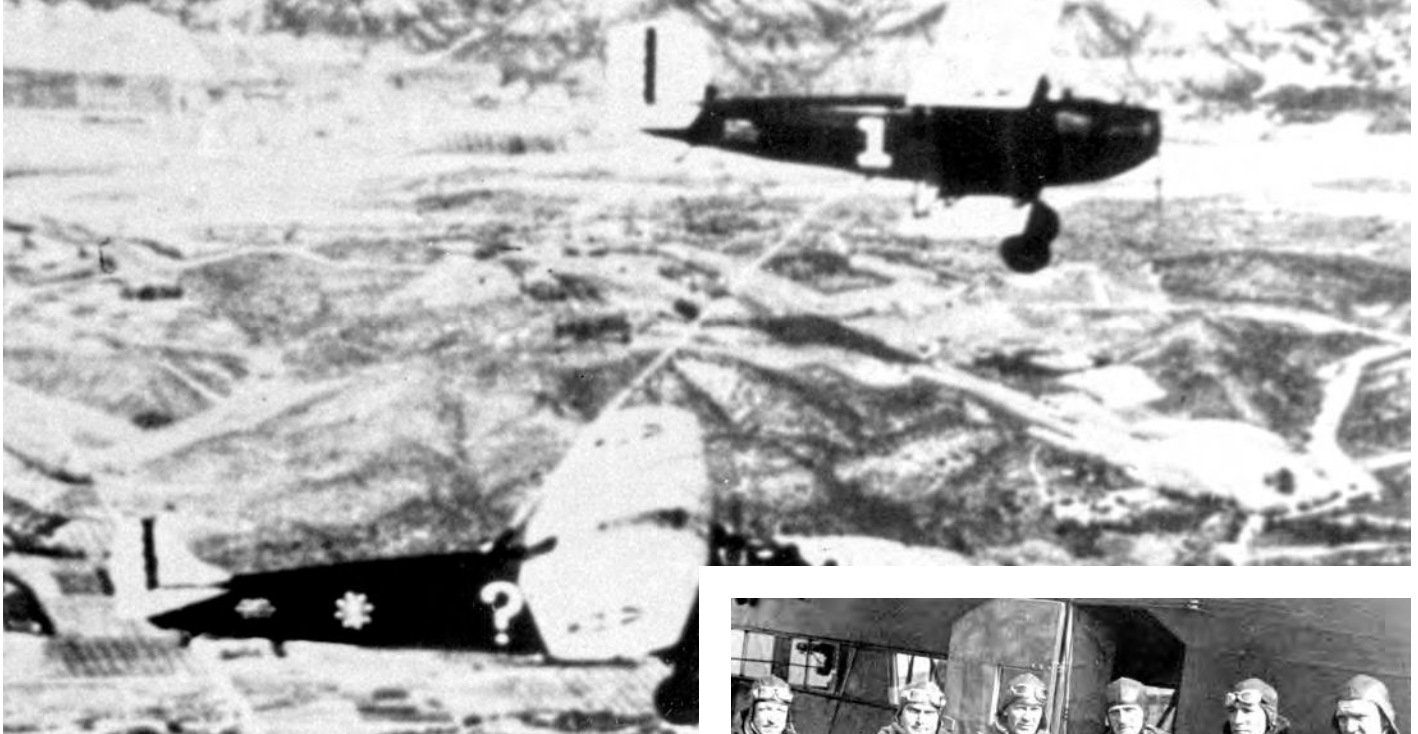

**This Issue's Quiz:** This September (2022) marks the Air Forces' 75th birthday. In keeping with the Air Forces' diamond anniversary, this edition's question relates to the earliest days of the Air Force and even before that. This person is linked to many key events in the Air Force's history. The impacts of the events still have a positive effect on the Air Force. He commanded a squadron during World War I. He helped prove the feasibility of aerial refueling. He commanded a huge strategic Air Force in Europe. He received the Collier Trophy. This person is also called by a nickname he earned while he was at West Point. He started his military career as an infantry officer. Who is this Air Force legend? What is his nickname? Can you name one of his post World War II accomplishments?





Air Force *Historical* Foundation  
P.O. Box 790  
Clinton, MD 20735-0790



To: Air Force *Historical* Foundation  
P.O. Box 790  
Clinton, MD 20735-0790

Visit Us Online at:  
[www.afhistory.org](http://www.afhistory.org)



Know the Past,  
Shape  
the Future



A I R F O R C E H I S T O R I C A L F O U N D A T I O N M E M B E R S H I P F O R M

NAME \_\_\_\_\_ PHONE \_\_\_\_\_ E-MAIL \_\_\_\_\_

STREET ADDRESS \_\_\_\_\_ CITY \_\_\_\_\_ STATE \_\_\_\_\_ ZIP \_\_\_\_\_

Associate Membership (\$25/year) (on-line magazine access) (Visit our Web site at [www.afhistory.org](http://www.afhistory.org))

Sustaining Membership (\$45/year)

GIFT FOR (NAME) \_\_\_\_\_

Gift Membership (\$45/year)

Life Membership (Inquiries to the Foundation)

ADDRESS \_\_\_\_\_

Become a Patron or Contributor (Please ask)

CITY \_\_\_\_\_ STATE \_\_\_\_\_ ZIP \_\_\_\_\_

\* Non-US recipients please add \$8.00 for postage (See Web site for additional membership options)

Check enclosed, payable in US Funds to Air Force *Historical* Foundation

Please charge my credit card (VISA/MasterCard/Discover)

CARD NUMBER: \_\_\_\_\_ EXPIRATION DATE: \_\_\_\_\_

SIGNATURE: \_\_\_\_\_ DATE: \_\_\_\_\_

Send form, along with your remittance to:  
**Air Force *Historical* Foundation**  
P.O. Box 790  
Clinton, MD 20735-0790





# Book Review Supplement

<i>Operation Restore Hope: U.S. Military Intervention in Somalia and the Battle of Mogadishu, 1992-1994</i> By Peter Baxter	Review by John Cirafici	69
<i>The Battle of Berlin: Bomber Command Over the Third Reich.</i> By Martin W. Bowman	Review by Golda Eldridge	70
<i>Defending Rodinu: Volume 1: Build-Up and Operational History of the Soviet Air Defence Force 1945-60</i> By Krzysztof Dabrowski	Review by Charles P. Wilson	70
<i>Because Our Fathers Lied: A Memoir of Truth and Family from Vietnam to Today.</i> By Craig McNamara	Review by John Cirafici	71
<i>Gotha Aircraft 1913-1954: From the London Bomber to the Flying Wing Jet Fighter</i> By Andreas Metzmacher	Review by Gary Connor	71
<i>Hitler's Air War in Spain: The Rise of the Luftwaffe</i> By Norman Ridley	Review by Steven D. Ellis	72
<i>F4U Corsair vs A6M Zero-Sen: Rabaul and the Solomons 1943-1944.</i> By Michael John Claringbould	Review by Gary Connor	73
<i>B-36 'Peacemaker' Units of the Cold War</i> By Peter E. Davies	Review by Scott A. Willey	73
<i>Operation Allied Force: Air War over Serbia 1999, Volume 2, Europe at War Series.</i> By Bojan Dimitrijevic & Lt Gen Jovica Draganic	Review by John Cirafici	74
<i>Shooting the Front Eastern Operations Volume One: Without Flyers, No Tannenberg: Aviation on the Eastern Front of 1914—Evolution of a Critical Role for Modern Warfare</i> By Terence J. Finnegan, Helmut Jäger, & Carl J. Bobrow	Review by Jon Barrett	74
<i>Close Call: RAF Close Air Support in the Mediterranean, Volume 1, Defeat in France to el Hamma 1939-43</i> By Vic Flintham	Review by Steven D. Ellis	75
<i>The Supersonic BONE: A Development and Operational History of the B-1 Bomber.</i> By Kenneth P. Katz	Review by Frank Willingham	76
<i>Guide to German Night Fighters in World War II: The Night Defenders of the Reich.</i> By Eduardo Manuel Gil Martinez	Review by Gary Connor	76
<i>American Aircraft Development: World War II Legacy—1945-1953 and the Korean War.</i> By Bill Norton	Review by Steven D. Ellis	77
<i>Innovating Victory: Naval Technology in Three Wars</i> By Vincent P. O'Hara & Leonard R. Heinz	Review by Frank Willingham	78
<i>Air Power Supremo: A Biography of Marshal of the Royal Air Force Sir John Slessor</i> By William Pyke	Review by Edward Young	78
<i>Black Snow: Curtis LeMay, the Firebombing of Tokyo, and the Road to the Atomic Bomb</i> By James M. Scott	Review by Frank Willingham	79
<i>Czechoslovak Arms Exports to the Middle East Volume 1: Origins, Israel and Jordan 1948-1989</i> By Martin Smisek	Review by Gary Connor	79
<i>Test Pilot: An Extraordinary Career Testing Civil Aircraft</i> By Chris Taylor	Review by Frank Willingham	80
<i>Naval Aviation in the Korean War</i> By Warren Thompson	Review by Steven D. Ellis	80
<i>When the Shooting Stopped: August 1945</i> By Barrett Tillman	Review by Gary Connor	81
<i>The First Jet Pilot: The Story of German Test Pilot Erich Warsitz</i> By Lutz Warsitz	Review by Gary Connor	82
<i>Astonishing Stories Pilots Tell Pilots: Marines, Navy, Air Force, CIA, Airlines, Civilian</i> By Robert N. Pripps	Review by Steven D. Ellis	82

## Operation Restore Hope: U.S. military intervention in Somalia and the Battle of Mogadishu, 1992-1994,

By Peter Baxter. Warwick UK: Helion, 2022. Glossary. Notes. Photographs. Maps. Illustrations. Pp. 64. \$ 29.95. ISBN: 978-1-915070-57-9

What was Restore Hope all about? A UN humanitarian mission led by the U.S. to save hundreds of thousands of Somalis on the verge of starvation? An attempt at nation building—imposed on a hostile population? Ultimately it was both, with a total disconnect between the two. Baxter captures, in a brief summary of Somalia's history, why it was not a place for outsiders to disregard complex clan and sub-clan relationships and attempt to reshape the political landscape against the reality on the ground.

In the aftermath of the Cold War and overwhelming victory in the Gulf War, the U.S. became the de facto world leader. When the horrific famine in Somalia became a nightly news item, President Bush felt compelled to act boldly. He moved past a much-smaller-scale relief operation and initiated military intervention to assure that a full-blown relief operation put an end to the crisis. Baxter

describes the American-led coalition of nations sent to Somalia to alleviate the starvation and end the famine.

In late December 1992, President George H.W. Bush, came to Mogadishu to thank U.S. personnel for their efforts. His message was unambiguous; the mission should be completed in the next few months, and we would all be going home. If only that were true. Somalia was of absolutely no value to U.S. national security interests. Once the humanitarian crisis had abated, America should have extricated itself from what was, in essence, an unending, Somali-inflicted nightmare. Unfortunately, the new Clinton Administration acted otherwise. The U.S. essentially became just one more of the warring factions (albeit the most powerful) in Mogadishu. What is especially reprehensible is that U.S. forces on the ground in Somalia were, for political reasons, denied the use of weaponry that would soon prove needed in their defense.

The section on Task Force Ranger and the Battle of Mogadishu illustrates what followed and makes it abundantly clear that politically driven policies coupled with a disjointed chain of command in Somalia would have unanticipated consequences. The afternoon of October 3, 1993

was a narrowly averted catastrophe. The Ranger force and its supporting helicopters suffered casualties and losses at the hands of Somali militia members during the battle. Only the belated intervention of the Quick Reaction Force—commanded by a U.S. general who, inexcusably, was not informed of the Ranger operation until things fell apart—came to their relief with U.S. troops augmented by Malaysian and Pakistani armor, thus preventing major losses. In the aftermath, the Clinton Administration conducted a face-saving insertion of substantial U.S. forces, later followed by a complete withdrawal.

During the election campaign, Governor Clinton had repeatedly criticized then-President Bush's interventionist policies. In the aftermath of the Battle of Mogadishu, Bush was, in turn, highly critical of Clinton's policy failure in Somalia. Bush emphasized that he had had a withdrawal plan to exit Somalia early on that had been dismissed by the new President. Thus, the Somalia sideshow continued to loom large on the domestic political scene.

The evacuations of Saigon in 1975, Mogadishu in 1994, and Afghanistan in 2021 have all painfully highlighted the dangers of intervention followed by a flawed-nation building effort. This monograph provides the story of one such failure.

*John Cirafici, Milford DE*



**The Battle of Berlin: Bomber Command Over the Third Reich.** By Martin W. Bowman. Philadelphia: Pen and Sword, 2020. Photographs. Notes. Index. Pp. 447. \$52.95. ISBN: 978-1-52678-638-8

This is my second review of a Bowman book (I previously read *Men Who Flew the Halifax*). This book could be considered as volume two of *Halifax*, even though this is supposedly about a battle, and the first one is about the crews of a specific airplane type. *Battle of Berlin* focuses on the experiences of Commonwealth crews and German aviators and civilians during RAF Bomber Command's efforts to knock Berlin out of the war. As was the case with *Halifax*, this book consists of first-person accounts. The key difference here is that Bowman includes stories from both sides. Stories from Bomber Command are augmented by accounts from both German civilians and night-fighter crews. These accounts from both sides—especially the civilian perspective—add depth and perspective that would be lacking in an account strictly focused on the military participants.

That said, this book suffers from the same shortcomings I identified in his other work. The title says it is about the Battle of Berlin, but there is no discussion of strategy, tactics, equipment, or employment for either side. Anything the reader gleans about any of these topics is incidental and, I have to say, accidental. The entire book is a formula

and reads almost like an encyclopedia. Raids are generally detailed by aircrew accounts from aircraft of varying units and include names, hometowns, a personal tidbit to add human interest, their activity during the raid, and their later life or disposition of remains if killed. This formula holds true even for the civilian accounts. Pathfinders and master bombers are mentioned, but there is no explanation of their purpose or how they came to be—even though they were a key to the British efforts to improve nighttime bombing accuracy.

The book suffers from terrible editing. There are at least eight instances of text (multiple sentences at a time) being repeated verbatim elsewhere. There are examples where Bowman discusses a subject as if it had already been introduced, but there was nothing related previously. Perhaps something was edited out? Some material (e.g., the system for using flares, Pathfinder operations, and use of USAAF members of RAF crews) is never explained. In places, personnel information unrelated to the current subject is stuck into the middle of a battle narrative. The narrative jumps around a lot making the story hard to follow. And, a number given in one location is often given in another with a different number! On the plus side, the book does contain several good chapters on Mosquito operations.

The book lacks a bibliography; there are no maps; nor is there a glossary for the multitude of abbreviations. Unlike in *Halifax*, German-language phrases are translated in the text; and the excellent photographs don't shrink from showing bombing casualties. Unquestionably, the volume of research necessary to amass this amount of first-person material is impressive. For someone interested in war stories and personal accounts, Bowman is a good source. However, at the high publisher price (significantly cheaper on Amazon), I'd pass this one by.

*Golda Eldridge, Lt Col, USAF (Ret), EdD*



**Defending Rodinu: Volume 1: Build-Up and Operational History of the Soviet Air Defence Force 1945-1960.** By Krzysztof Dabrowski. Warwick UK: Helion & Company, 2022. Maps. Tables. Diagrams. Illustrations. Photographs. Notes. Appendices. Bibliography. Index. Pp. 80. \$29.95 paperback. ISBN: 978-1-915070-71-5

In this book, Dabrowski takes a systematic and pragmatic look at the Soviet air defense forces during the Cold War period beginning from immediately at the end of World War II to 1960. In his research, he pulls from a wide variety of sources and material that has been declassified and released since the end of the Cold War in 1991. There are a variety of period illustrations, photographs, and maps along with modern color images of the related aircraft types

When World War II ended in 1945, mistrusting ten-



sions grew between East and West. "World peace" did not arrive as thought. Instead, a new "Cold War" emerged. The Soviets had to refocus their air defenses to counter threats from their previous World War II allies. Making things worse, the technology and equipment of Soviet air defense forces were rapidly becoming obsolete. With the outbreak of the Korean War, the need for an effective combination of command and control, radars, interceptors, and surface-to-air missiles became more acute.

Within this period of just fifteen years, the air defenses of the Soviet Union evolved from anti-aircraft guns and piston-engine fighters to surface-to-air missiles along with Mach 2 interceptors armed with missiles. While the perceived threat, from the West, of nuclear armed aircraft and bombers did not appear over the Soviet Union, many reconnaissance aircraft did. The Soviet air defenses were tested and did engage many times to counter the perceived or actual allied intruders.

Additionally, and of interest, are the accounts of shoot-downs of various U.S. military aircraft, operating not only around the periphery of the Soviet Union, but also the claimed airspace of the Soviet Union.

This book is the story of how this remarkable progress was achieved and how these assets performed in actual combat against U.S. and allied aircraft violating, or allegedly violating, Soviet airspace. I heartily recommend this book for students of the period and look forward to reviewing the next volume when it is published.

*Colonel Charles P "Chuck" Wilson, USAF (Ret); Chairman of the Board, The Cold War Museum®; U-2 pilot and commander; NASM docent*



**Because Our Fathers Lied: A Memoir of Truth and Family from Vietnam to Today.** By Craig McNamara. New York: Little, Brown and Company, 2022. Photographs. Illustrations. Pp. xiii, 269. \$29.00. ISBN: 978-0-3162-8223-9

This is a story of deeply conflicted emotions carried for nearly a lifetime by then-Secretary of Defense Robert McNamara's son and how they are, in many ways, a consequence of his father's role as a key architect the Vietnam War.

Why is this book important? It is not just the falsehoods about the war that, on a personal level, divided father and son. In the greater context, it is the lies by the father and his cohorts to the American people about the war and their complicity in callously waging it. The first case can be measured only by what was lost between the two when the father never acknowledged his role in an unconscionable war. In the second case, the impact must be measured by the scale of lives lost and the massive destruction visited upon Southeast Asia's people and environment.

The clashing of viewpoints about the war held by father and son paralleled the American people's rising doubts about the war.

The central part of the story is how young McNamara went from unquestioning son to an openly anti-war activist. This radical change did not fully manifest itself, however, until the father had left to become president of the World Bank, where his disingenuous policies undermined the stability of other countries.

As with many who served in combat in Vietnam, I was a product of the underclass. Consequently, as I read accounts of the McNamara family's summer camping trips with supporting mule trains and crew, I felt some resentment of the author's earlier life of privilege. Perhaps his expressed sense of guilt was for having not served in his father's war and for possessing a quality of life that gave him freedom to make choices. This was in stark contrast with young men his age who lacked choices and died in that conflict. His sense of loss pales in contrast to the sacrifices of those who had served and gave so much.

An especially interesting part of the book, at least for me, is Craig McNamara's incredible road trip of self-discovery through Latin America where he became a participant in events and a friend to many, everywhere he went. Perhaps it is personally fascinating, because I too had entered an introspective period after returning from the worst year of the Vietnam War. The author's experiences also reminded me of Che Guevara's motorcycle diaries. He kept them as a university student during his travels through South America while also seeking self-discovery.

Craig McNamara was once again disappointed when his father played a role in undermining the democratic government in Chile. This took place while a radicalized son witnessed it in Santiago.

What is clear in reading this book is that Robert McNamara never deviated from his non-communicative relationship with his son, leaving the author with a bittersweet memory of his father. More than that, Robert McNamara went to his death without ever acknowledging his duplicity in a war that was destructive for all involved.

This is a very interesting and informed book that must have been difficult to write. We owe it to McNamara and to ourselves to read it.

*John Cirafici, Milford DE*



**Gotha Aircraft 1913-1954: From the London Bomber to the Flying Wing Jet Fighter.** By Andreas Metz-macher. Stroud UK: Fonthill, 2021. Photographs. Illustrations. Appendix. Bibliography. Notes. Pp. 159. \$35.00. ISBN: 978-1-78155-706-8

The names of German aircraft of World War I have become synonymous with their mission. "Fokker" is for-

ever linked to pursuit aircraft. In the same way, “Gotha” suggests bombers. Gotha, a company that was founded to produce carousels, instead produced massive wood-and-fabric machines capable of attacking London and other strategic targets with hundreds of pounds of explosives. This book provides an interesting, if incomplete, insight into this small industrial concern and its contribution to aviation.

Metzmacher concentrates on the airplanes themselves. His book is organized by aircraft missions and the Gotha products intended to fulfill them. There are very brief segments on important people who worked for Gotha and similar short segments on the social, political, and economic environment of the times.

Aircraft segments are accompanied by a high-quality photograph and details of the propulsion system used. This organization leads to a choppy narrative. While the segments are informative, they are incomplete. There is no information on design, materials, or production. Even though Gotha rapidly grew from building small, single-seat aircraft to massive bombers, there is no discussion of how the company developed the required aerodynamic information for such a radical shift in product. Gotha even explored asymmetrical aircraft designs, but Metzmacher provides no real explanation of how or why. He frequently mentions metal-tube and wooden-frame construction but makes no mention of how the company trained its workforce for this approach.

After the war, Gotha and its competitors underwent a massive downsizing forced by the victorious allies, but the company never offered a successful design when Germany began to re-arm. The best it could do was to provide licensed production of a variety of platforms of other designers. The Gotha factory eventually did limited work on various glider programs but never regained the esteem it enjoyed during the Great War. However, that contribution was sufficient to attract the attention of the Eighth Air Force; the Gotha factory received several visits from B-17s and B-24s. Metzmacher notes that, while buildings were heavily damaged, the machine tools in the building were unscathed, and production resumed quickly. In the final months of the war, the RLM determined that Gotha had sufficient capacity support the Horten brother’s jet flying-wing program. Metzmacher offers some interesting insight into the actual status of the Horten IX, pointing out that the design was far from production-ready, and Gotha hosted numerous meetings to resolve these issues.

At the end of World War II, the Gotha factory was in the Soviet occupation zone. Over a three-year period, the entire factory was dismantled and taken back to Russia as reparations.

*Gotha Planes* is an interesting work and is an easy, if choppy, read. The photographs are noteworthy. To find such a plethora of information on so many unique aircraft is the hallmark of a valuable research tool. But keep in mind that

the information provided is limited, and there is a great deal of pertinent information that is not found in the book.

*Gary Connor, docent, Smithsonian National Air and Space Museum’s Udvar Hazy Center*



**Hitler’s Air War in Spain: The Rise of the Luftwaffe.** By Norman Ridley. Philadelphia: Pen & Sword, 2022. Photographs. Notes. Appendix. Index. Bibliography. Pp. vii, 206. \$34.95. ISBN: 978-1-39908-472-7

After selling his business, Norman Ridley pursued his passion researching historical developments before and during World War II. He has completed three other works on military aviation in Europe before World War II, the European perception of Adolf Hitler before the war, and a British intelligence operation.

Proceeding in chronological order, Ridley examines the effects of aerial operations on the conflict between Spain’s lawful government (usually referred to as the Republicans) and the insurrectionists, known as the Nationalists. The war began with the Nationalist’s unsuccessful *coup d’etat* in July 1936. It concluded in April 1939 with a Nationalist victory.

As the war progressed, both sides became increasingly dependent on outsiders for air support. In the beginning, the Soviet Union provided the Republicans with superior combat aircraft. Over time, however, the Germans dispatched increasingly more effective airplanes to assist the Nationalists. The Italians also aided the Nationalists.

German airlift, in the form of Junkers Ju 52 tri-motor transports, played a very critical role in the earliest days of the conflict. These aircraft transported thousands of Nationalist troops from Spanish Morocco to Spain proper. This operation enabled the Nationalists to establish a foothold.

Ridley’s efforts to trace the progression of the land battle and the subsequent relocation of air assets are severely hampered by the absence of maps. Maps are always crucial to interpreting the significance of military operations. Both sides shifted air assets depending on the ground war.

The book examines both technology and evolving doctrine. The Germans employed air power effectively in many ways. Besides airlift, these included reconnaissance, close air support, interdiction, strategic bombing, and anti-shiping. Aircraft such as the Messerschmitt Bf 109 fighter, Junkers Ju 87 dive bomber, and the Heinkel He 111 bomber all experienced their first use in combat in Spain. Over time, the Germans became increasingly proficient at close air support. Nevertheless, they also attempted to sustain a strategic bombing campaign against the Republican infrastructure. Sometimes this resulted in area bombing of cities with mixed results. One lesson from World War I that had to be re-learned was the vulnerability of bombers to fighters. Consequently, the Germans switched to night



strategic operations. Only in the final months, as Soviet support diminished, were the Germans able to achieve air supremacy. Of course, with the Bf 109s they had been able to gain air superiority over the battlefield. From a tactical standpoint, the Germans were the first to employ the finger-four fighter formation in combat.

This book is best suited for readers unfamiliar with the role of air power in the Spanish Civil War. Unfortunately, Ridley relied exclusively on secondary sources. Students of the conflict are unlikely to find much new here.

*Steven D. Ellis, Lt Col, USAFR (Ret), docent, Museum of Flight, Seattle*



**F4U Corsair vs A6M Zero-Sen: Rabaul and the Solomons 1943-1944.** By Michael John Claringbould. Oxford UK: Osprey. 2022. Photographs. Illustrations. Maps. Pp. 80. \$22.00 paperback. ISBN: 978-147285061-4

When Osprey first introduced its “Duel” series, the product was well received. As always, the publisher developed a specific format for its authors to follow. First, identify a well-defined campaign or battle. Then, introduce the pertinent weapons and combatants, including first-person accounts, when possible, to balance the tech-heavy analysis of the hardware. Finally, draw some conclusions that show how the “duel” affected future events.

In this case, the Allied combatant is the newly introduced F4U Corsair; a design that would serve with distinction through the remainder of World War II and into Korea. Its Japanese adversary is the A6M Zero-Sen, a proven veteran of the Pacific War that was beginning to show its age. Improvements to its engine and armament and reliance on proven tactics kept it viable for the Imperial Japanese Navy, but its time was limited.

Eighteen Marine fighter squadrons were equipped with the Corsair from its introduction through early 1944, when the Japanese withdrew from the area. Some 129 aircraft were lost in combat, while another 175 were lost to operational accidents (e.g., weather, equipment failure, friendly fire). Equivalent data for the Zero-Sen are not provided, but Claringbould cites Allied sources supporting a 4:1 victory ratio; Japanese sources adamantly support a 5:1 ratio.

There is no question that, in the earliest days of their deployment, Marine pilots struggled to develop tactics that took advantage of the Corsair’s performance and equipment advantages. The Corsair’s radios, alone, permitted coordinated engagement as well as fighter direction from ground stations and coast watchers. Zero pilots relied solely on hand signals developed during the Great War. Curiously, pilot interviews emphasized the importance of maintaining altitude and energy and avoiding low-speed turning engagements that had always been the Zero’s forte. The

newest armchair aviation historian recognizes these were the same lessons Chennault drilled into the Flying Tigers. Following them allowed less capable Tomahawks, Wildcats, and Buffalos to survive and even thrive against the Zero. So how was it the Marines had to learn the same lessons all over again?

The book is the same-quality Osprey product that the buyer might expect. It includes quality photographs and uses drawings to advantageous effect when discussing tactics. Interestingly, for an experienced author, Claringbould’s writing is sometimes clumsy. For example, “Curious Australian and New Zealand personnel present ignored them.” How the personnel could be simultaneously “curious” and “ignoring” is a mystery that only the editors can resolve.

*Gary Connor, docent, Smithsonian National Air and Space Museum’s Udvar-Hazy Center*



**B-36 ‘Peacemaker’ Units of the Cold War.** By Peter E. Davies. Oxford UK: Osprey Publishing, 2022. Tables. Illustrations. Photographs. Appendices. Index. Pp. 96. \$24.00 paperback. ISBN: 978-1-4728-5039-3

Davies has written several dozen books for Osprey, usually on Vietnam and more modern military aircraft. This is a little outside his normal genre, but he has done an excellent job of telling the story of an iconic Cold War bomber.

Convair’s ten-engine behemoth has been a favorite of mine since, as a kid, I watched B-36s out of Travis AFB fly over my house to make GCA approaches into NAS Moffett Field; and I saw (many times) Jimmy Stewart’s wonderful movie, *Strategic Air Command*, with its fantastic ground and aerial coverage of the Peacemaker. There have been bigger works on the plane (Meyers Jacobsen’s 400-page *Convair B-36: A Comprehensive History of America’s “Big Stick”* was excellent). But, in just 96 pages, Davies tells most readers all they really need to know about America’s last piston-engine bomber.

The title is really misleading: Davies covers far more than B-36 units. He provides a comprehensive history of the evolution, development, testing, failures, operational uses, proposed uses, and retirement of all of the various models of the B-36. In line with the higher-farther-faster-heavier payload trend in bombers, the Peacemaker was conceived before U.S. entry into World War II when there was a possibility that bases in the UK, North Africa, and Greenland/Iceland might not be available. The USAAF would have had to bomb the Third Reich from the continental US. With the successes of the B-17, B-24, and B-29, the B-36 wasn’t needed during the war and didn’t fly until after V-J Day. With the advent of nuclear weapons, and the development of ever bigger nukes, the only thing

capable of carrying these to the new enemy's homeland was the B-36. Despite tremendous problems with early aircraft (reminiscent of the B-29 story, but magnified because of its size), the USAF had to press ahead with the aircraft. Eventually about 400 were built and operated from 1948 until their retirement in early 1959—without ever firing a shot or dropping a bomb in anger.

The amount of detail about the B (bomber) and RB (strategic reconnaissance) versions is very good for a book of this size. Davies covers missions (some in excess of 40 hours), crews (15-26 depending on mission and configuration), accidents, and the major systems aboard these huge airplanes. But he also covers the FICON (FIghter CON-veyer) GRB-36s that carried YRF-84Ks, dropped them for their recce dashes, and then recovered them in flight. The XC-99 double-deck transport is discussed as is the NB-36 proposed nuclear-powered variant. Osprey's usual high-quality photographs run throughout, and there are 30 excellent sideview illustrations showing the wide range of models and units.

There are a couple of unfortunate gaffs that Davies or Osprey should have picked up on. The worst was when a B-36 dropped the 8 November 1952 *King* bomb of 500 megatons. Despite these errors, for my money this is the history to read for those interested in this fantastic Cold War weapon system.

*Col Scott A. Willey, USAF (Ret), Book Review Editor, and former National Air and Space Museum docent*



**Operation Allied Force: Air War over Serbia 1999, Volume 2, Europe at War Series.** By Bojan Dimitrijevic and Lt Gen Jovica Draganic, Warwick UK: Halion and Company, 2022. Illustrations. Photographs. Maps. Notes. Pp. 90. \$29.95 paperback. ISBN 978-1-915070-65-4

This monograph examines the NATO air campaign conducted primarily against Serbia in response to that country's operations in Kosovo. In March 1999, NATO initiated attacks on Serbian targets and continued the campaign until mid-June. The two authors (a senior historian in Serbia's war ministry, and a general officer serving during the war) are highly informed Serbians who have drawn on their first-hand knowledge of the Serbian responses. They drew on published reports and interviewed participants on the NATO side. Because this volume seamlessly continues from Volume One, the two should be read sequentially.

Coordinating the near simultaneous operations of strike packages tasked to different NATO units and launched from a multitude of bases was difficult. Cross communications between units in the same strike package but from different bases was often challenging. Further complications resulted from significant errors in intelli-

gence that caused disastrous errors in targeting. The most egregious example was the attack on the Chinese Embassy in Belgrade. The subsequent political fallout nearly derailed the air campaign and caused problems within NATO. Collateral damage had the same negative impact. Supreme Allied Commander General Clark later said that public pressure had managed what Serbian air defenses could not—limit NATO airstrikes.

In addition to discussions of participating aircraft types, the authors describe the weapons introduced for the first time by the USAF, such as the B-2, and their impact on the campaign. Also highlighted were "Graphite bombs" used to temporarily disable Serbian electric grids. The A-10's use of depleted uranium munitions, however, proved controversial. Other weapon systems (e.g., precision guided munitions and unmanned aerial vehicles), only recently tested in the Bosnian campaign, found wider application against Serbia.

Not everything went smoothly for the allies. Difficulties with the Vicenza Combined Air Operations Center (CAOC) raised a question from non-U.S. NATO members: why wasn't the Ramstein CAOC used instead since it had the necessary experience and expertise with NATO forces? One senior RAF officer said that when Operation Allied Force commenced without using the Ramstein CAOC, all that expertise went out the window. The U.S. joint task force method of operations badly alienated other NATO participants.

On the Serb side there were some successes. They were very effective using their electronic intelligence capabilities, in fact revealing when the otherwise highly stealthy B-2 was in their airspace. The Serbs also realized a degree of success in protecting their integrated air defense systems by employing rapid relocation tactics and concealed fiber optics cables. The air force did conduct a handful of strike missions in Kosovo and flew a small number of MiG-29 intercept sorties.

The authors have provided informed observations about the conflict, especially from the Serb perspective. Additionally, the narrative is reinforced with an excellent selection of photographs and illustrations of aircraft and ground based defensive systems, and an assortment of actual aerial photos of targets. Halion, consistent with their reputation, has published a highly usable reference for the air campaign against Serbia.

*John Cirafici, Milford DE*



**Shooting the Front Eastern Operations Volume One: Without Flyers, No Tannenberg: Aviation on the Eastern Front of 1914—Evolution of a Critical Role for Modern Warfare.** By Terence J. Finnegan, Helmut Jäger, and Carl J. Bobrow. Durham NH: Dawdle Publishing, 2022. Maps. Tables. Diagrams. Illustrations. Photo-



---

graphs. Notes. Appendices. Glossary. Bibliography. Index. Pp. xiv, 338. \$59.99 paperback. ISBN: 978-1-955072-02-1

Those of you who have read Finnegan's *Shooting the Front* will find this book contains a much broader look at the earliest part of World War I on the Eastern Front. The authors cover much more than German and Russian aerial observation practices. In describing the development of aerial reconnaissance over the Eastern Front, they provide a detailed examination of the factors behind the command decisions (on both sides) during the first eight months of the war, including aerial and cavalry reports, radio intercepts, captured documents, and information obtained from civilians.

Given the scope of this book, readers will want to download the maps from <https://shootingthefront.com>. Diagrams are provided for the pre-war and mid-1915 aviation organizations; but, given the emphasis on the vast sweep of the action, the index can be a great help. Here, the entries for "German Army" and "Russian Army" break out the component units for each. This will make a difference in following the action for those of us who haven't been living with the subject for the past several years.

The introductory chapters provide a look at pre-war military aviation in Germany and Russia. Eight chapters then cover the sweep of the armies across *Ostpreussen* from the outbreak of the war through the end of Tannenberg in September 1914. Two further chapters follow the Russian Army's further defeats at the Masurian Lakes and their final withdrawal from *Ostpreussen*. Over this time period we are shown the factors influencing the German and Russian maneuvers and how much, or little, reliance the two sides placed on their aerial reconnaissance versus the more customary (for the time) sources of intelligence. Reorganizations and reordering of priorities discussed in the final two numbered chapters reflect appreciations of both sides of the action over the opening months of the war, including a new Russian appreciation of the potential of aircraft—particularly their *Il'ya Muromets*. An unnumbered chapter provides an "after action" review of the campaign, with assessments of what worked, what didn't, and the historical impact of the events as they played out. The three appendices provide a career capsule of Ivan Chekhutov, a stalwart aviation advocate; the key German sorties of August 30; and a Russian pilot's remarkable escape after crashing between the lines.

I did find that the use of dark colors in maps and diagrams, and of placing photographs in colored blocks, made them hard to read. This wasn't as much an issue in the ebook, but the ebook lacked the index, which I would much rather have.

This book is a valuable in-depth study of a largely underappreciated part of the Great War. It offers much more than is implied by *Shooting the Front Eastern Operations*. If the subsequent volumes provide similar depth, this se-

ries will be a significant reference on the entire Eastern Front during World War I.

*Jon Barrett, volunteer photographer/researcher, National Air and Space Museum*



**Close Call: RAF Close Air Support in the Mediterranean, Volume 1, Defeat in France to el Hamma 1939-1943.** By Vic Flintham. Manchester UK: Crecy Publishing, 2020. Maps. Tables. Diagrams. Photographs. Illustrations. Notes. Appendices. Glossary. Bibliography. Index. Pp. 207. \$44.95. ISBN: 978-1-90210-964-0

Flintham is a former National Health Service administrator and lifelong aviation enthusiast who has completed six books, primarily about British military aircraft and operations. He also has written several articles for some of the United Kingdom's leading aviation magazines.

This volume examines the development of close air support by the Royal Air Force (RAF) for the British army. It begins with some of the lessons learned and forgotten after World War I. As an independent branch, the RAF had limited interest in directly supporting the army. As events evolved in the 1930s, RAF leaders focused on strategic bombing and air defense. Perhaps feeling abandoned, the army formed the Army Co-operation Command. This organization depended on light aircraft for limited tactical reconnaissance and artillery spotting.

After the Battle of France ended in June 1940 with the British Expeditionary Force's evacuation to the UK, military leaders initiated a review of how the British Army and RAF could better cooperate. Changes were slow in coming. As in the United States, army commanders wanted their own private air forces, while RAF leaders wished to have central control.

In the North African campaign, both the Axis (Germany and Italy) and British Commonwealth ground forces mounted successful offensives rolling back and forth along the Egyptian and Libyan coasts. Whoever controlled the skies could better control the desert and the seas, so air superiority was paramount. The rapid movement of the front lines presented many challenges for basing aircraft. Communication shortcomings between the army and RAF caused hard feelings.

As increasing numbers of American-built, Lend-Lease aircraft arrived, the RAF gradually outgrew the Axis air forces. More frequent achievement of local air superiority enabled the RAF to increasingly interdict Axis lines of communication. Still, there were a lot of hiccups before timely close air support could be provided. In early 1943, the Desert Air Force commander, Air Vice Marshal Harry Broadhurst, assigned RAF pilots in armored cars close to the front lines. Equipped with radios, they were authorized to request air strikes from aircraft orbiting nearby. This

---

model, a radical change from a far more centralized and cumbersome approach, would become the standard for the British and American tactical air forces when their armies broke out from Normandy in the summer of 1944.

Combining primary and secondary sources, Flintham details the impact of air power on the various land battles in North Africa. He covers much more than just the challenges of timely close-air support. Many of the more than 200 photographs come from his personal collection.

This book is highly recommended for anyone with an interest in the integration of land and air power or in the North African campaign. The only shortcoming concerns the layout. The smaller-than-usual sans serif font (probably to save space for more text) challenged my aging eyes. Younger readers probably will find this feature less distracting.

*Steven D. Ellis, Lt Col, USAFR (Ret), docent, Museum of Flight, Seattle WA*



**The Supersonic BONE: A Development and Operational History of the B-1 Bomber.** By Kenneth P. Katz. Havertown PA: Pen and Sword Books, 2022. Bibliography. Photographs. Illustrations. Tables. Pp. 392. \$50.00. ISBN: 978-1-39901-471-7

Kenneth Katz was educated in aerospace engineering at MIT and the University of Michigan. He has over three decades of experience as a U.S. Air Force officer, flight-test engineer, and project manager. He is currently employed as a staff project engineer for a major aerospace contractor. Katz holds a commercial pilot certificate with instrument rating and has flying experience as an observer and crew. He is a senior member of the Society of Flight Test Engineers. He is the author of three patents, several conference papers, and two previous books about modern military aircraft.

When Katz wrote this book, the B-1B Lancer had experienced almost 20 years of combat experience. The aircraft had also projected global reach and power and has been a highly successful weapon system. Moreover, it has been employed in ways that would have been unimaginable when the swing-wing bomber was first conceived!

Katz begins with early concepts and influences on B-1 design. These include WS 110A, the B-58 Hustler, the Boeing model 804-4, and the XB-70. These led to the development of the B-1A Advanced Manned Strategic Aircraft (AMSA or, as some pundits dubbed it, America's Most Studied Aircraft). He covers not only the new set of warfighting priorities facing aircraft design, but the ever-changing political priorities that influenced requirements, funding, and the very life of the B-1 program. He presents the details of design and development, covering major assemblies, structure, engines, avionics, crew accommoda-

tions, and the like. Systems and flight testing, ordinance accommodation, and weapons delivery are also addressed. In fact, Katz covers most attributes of the design, development, and operational introduction of a new, cutting-edge weapons system.

After describing the ultimate evolution to the B-1B, he gives many examples of successful and unsuccessful flight testing and combat operations in various theaters. He covers operations after the Cold War, the B-1B's combat debut, and its operations in the Global War on Terror. He describes maintenance and modernization of the aircraft and its present roles and future use. In Katz' words, the B-1B was born after decades of controversy and false starts. It had a troubled childhood. It was modernized to meet the challenges of a world situation very different than the one for which it was intended. It was adapted to become one of the pillars of American airpower with a highly successful combat record.

Every once in a while, we come across a must-read book. This is one of them. It is a great reference for historians, pilots, engineers, and even policymakers. Both the writing and photos are excellent. The acronyms list provided is a must, as there are many used throughout. I would prefer a detailed index to ease in finding needed references. However, the lack of one is not a showstopper. The book has a definite place on the enthusiast's bookshelf.

*Frank Willingham, National Air and Space Museum docent*



**Guide to German Night Fighters in World War II: The Night Defenders of the Reich.** By Eduardo Manuel Gil Martinez. Turka, Poland: Kagero, 2021. Photographs. Illustrations. Glossary. Pp.140. \$46.95 paperback. ISBN: 978-836667368-7

Kagero continues its evolution from a modelling magazine to serious content-based military topics. The book offers information on the history, organization, and equipment used by the Luftwaffe in its nocturnal missions. Martinez even adds "bonus" material: a brief discussion of Japanese night fighters of the period, and his own rank order of German aircraft from best to worst. Amply supported by numerous photographs and drawings, the book is a nice one-volume discussion of the subject. Unfortunately, it also has serious problems.

At times, the obvious English translation is nearly unreadable. The combination of proofing errors, odd syntax, and clumsy word choice had me wondering frequently just what Martinez was trying to say. Readers familiar with the subject or with Luftwaffe history and equipment may have an advantage in deciphering a thought—which may or may not be the actual thought Martinez is trying to communicate. The large number of photographs help clarify



the text; but, in many cases, the captions suffer from the same problem as the text.

An equal concern was the lack of balance in the narrative. German pilots are often referred to as “brave,” while allied aircrews are anonymous. German boys are shown operating searchlight equipment, but no mention is made of the *Lufthelferin* and the role they played in the Luftwaffe’s command-and-control centers. The book has a decidedly unbalanced feel, which led me to question many of Martinez’s ideas and opinions.

There are portions of the book that I found very good. The discussion of airborne radar equipment and armament characteristics was well presented. But even strong sections had uncited technical assessments and opinions that weakened Martinez’s arguments. However, he did an excellent job addressing night-fighter operations and equipment on the Eastern Front. The Soviets used night-raider tactics to keep German forces fatigued and off balance. The most famous Soviet unit tasked with this mission was the 588th Night Bomber Regiment or “Night Witches.” Using the antiquated Po-2 biplane, the all-female pilots punched well above their weight. To counter the Po-2s, the Luftwaffe attempted to retrofit radar equipment on many different airframes, from the Fi 156 Storch to the Fw 189 Uhu, trying to find a platform that could fly at low altitude and low speed to detect and destroy the Night Witches. Martinez found photographs of some of these field modifications.

There is no question that technical language translations are extremely challenging. Verbatim translation frequently misses the intent of the words. Separate glossaries are frequently included to ensure readers can navigate technical vocabularies. It behooves international publishing houses to ensure their authors’ ideas are not lost in translation. In this case, it is not possible to determine whether Martinez, the editorial staff, or both dropped the ball, but someone did.

*Gary Connor, docent, Smithsonian National Air and Space Museum’s Udvar-Hazy Center*



**American Aircraft Development: World War II Legacy—1945-1953 and the Korean War.** By Bill Norton. Charleston SC: Fonthill Media, 2021. Glossary. Photographs. Tables. Notes. Bibliography. Index. Pp. 510. \$70.00. ISBN: 978-1-78155-828-7

Norton is a former flight-test engineer with 40 years’ experience, including 20 as an Air Force officer. He has written over a dozen books, several of which focus on American aircraft and glider development during World War II. This volume continues that theme during a critical time in aviation progress—the transition from piston- to turbine-powered aircraft.

Using a topical approach, Norton sets the scene with

his early chapters emphasizing the role of U.S. military and naval aviation as the United States transitioned from its dominance as the world’s most powerful nation to its bipolar competition with Communism as manifested in Joseph Stalin’s Union of Soviet Socialist Republics. Before examining various aircraft types, he devotes a chapter to the post-World War II research driven by the military and the National Advisory Committee for Aeronautics (NACA). NACA played a crucial role in helping the United States emerge as the world’s premier aviation innovator in the late 1940s and early 1950s. He also examines how U.S. military and naval aviation perceived their missions and how technological choices reflected doctrinal changes with the introduction of nuclear weapons.

As should be expected, the obvious aircraft types are discussed in considerable detail. However, Norton goes beyond bombers and fighters. He includes chapters on airlift, helicopters, and naval-specific aircraft. His chapter entitled “Special Types” covers reconnaissance, trainers, rescue, Army liaison, and drones.

*Aerial Weapons* discusses the transition from the .50 caliber machine gun to the 20-millimeter cannon and the first air-to-air missiles. Guided bombs, robot planes, surface-to-air missiles, and cruise missiles are all examined. The final chapters summarize the impact of air power in the Korean War and the many advances in aeronautics. One could argue that the book’s scope parallels aviation progress between the beginning and end of World War I and the emergence of the all-metal airplane and air-cooled radial engine in the late 1920s and early 1930s.

Norton thoughtfully includes a comprehensive glossary. This helps readers who are unfamiliar with aeronautical concepts better understand the impact of changes in design, particularly those caused by more powerful powerplants leading to supersonic performance. Improved engines, of course, have always been essential in fostering progress in aviation. To that end, he includes a table demonstrating turbojet improvement between 1944 and 1952.

Engine success or failure was critical in determining whether many aircraft advanced from prototypes to production. Consequently, a chapter devoted to progress in engines, including turboprops, would have been useful. Norton visited various institutions in his quest for appropriate photos; those selected for publication reflect that effort.

While this work is packed with information reminiscent of the British Putnam series, it would have benefitted from professional editing, as there are frequent typographical and syntax errors. This book is best suited as a reference work for students of post-World War II aviation development.

*Steven D. Ellis, Lt Col, USAFR (Ret), docent, Museum of Flight, Seattle*



---

**Innovating Victory: Naval Technology in Three Wars.** by Vincent P. O'Hara and Leonard R. Heinz. Annapolis MD. Naval Institute Press. 2022. Notes. Bibliography. Index. Maps. Tables. Photographs. Pp. 320. \$29.52. ISBN: 978-1-68247-732-8

O'Hara is an independent naval historian and the author of thirteen works. The Naval Institute Press awarded O'Hara its 2015 Author of the Year. He represented the United States at the 75th anniversary commemorations for Operation Torch held in Algiers and Oran, Algeria. O'Hara's work has also appeared in many periodicals and annuals including *Naval History*, *Warship*, *World War II Magazine*, and *Storia Militare*. He holds a history degree from the University of California, Berkeley.

Leonard R. Heinz worked for many years as a financial-services lawyer while maintaining an active interest in military and naval history. He has authored articles and designed war games on naval topics with an emphasis on tactical naval simulations. He holds a history degree from the University of Pennsylvania.

Modern naval technology is the sum of the of the elements involved in the invention, development, production, and use of specialized weapons, tools, and platforms. The 20th century was a time of profound technological change. This change began in the mid-19th century with the advent of coal-fired steam engines, armor, and mines. Torpedoes also appeared, and radio was introduced. Naval technology became three-dimensional in the early 20th century with the development of practical submarines and aircraft. It then expanded into the electromagnetic spectrum with the advent of radar and sonar. During the current period, naval technology has incorporated atomic energy and progressed to satellites, computers, drones, data networks, and artificial intelligence.

This book describes how the world's navies incorporated new technologies into their ships, practices, and doctrines. Six core technologies are addressed: mines, torpedoes, radio, radar, submarines, and aircraft. O'Hara and Heinz discuss the nature and history of each of the subject technologies, the state of the technology when it was first employed, how it was expected to be used, how technologies were subsequently improved or modified, the development of countermeasures, and how doctrine and ancillary improvement technologies were incorporated to improve effectiveness. They also make liberal use of case studies to demonstrate and clarify their findings.

While O'Hara and Heinz did not intend to make this book into a complete history of naval weapons, assistive tools, and delivery platforms, they have presented a thoughtful and well-researched synthesis of selected-capability discovery, evolution, and exploitation. The book enhances the understanding of how technology influences both naval doctrine and warfare. While not confined to air power alone, air and several tangential technologies are well covered. It is well written and includes substantive

supportive data. It is a valuable addition to the naval history enthusiast's bookshelf.

*Frank Willingham National Air and Space Museum docent*



**Air Power Supremo: A Biography of Marshal of the Royal Air Force Sir John Slessor.** By William Pyke. South Yorkshire UK. Pen & Sword Aviation, 2022. Maps. Notes. Appendices. Photographs. Bibliography. Index. Pp. vii, 262. \$49.95. ISBN: 978-1-39909-552-5

While he never achieved the broad recognition of some of his peers in the Royal Air Force, Marshal of the RAF Sir John Slessor was one of the pivotal figures in the RAF from the late 1930s until his retirement as Chief of the Air Staff in 1952. As a senior commander, planner, consummate practitioner of coalition air warfare, and theoretician of air power, Slessor made vital contributions to the success of Allied air power during World War II and to developing the RAF's postwar strategy of nuclear deterrence. Pyke's new biography of Slessor, based on archival sources, broad reading in the literature, and access to the Slessor family papers, is a welcome addition.

Pyke traces Slessor's early career in the RAF beginning with his service in the Royal Flying Corps in the Middle East and over the Western Front in World War I. During the interwar years, Slessor held various command and staff positions. His four years as a lecturer on air power at the Royal Army Staff College at Camberley provided the basis for his first book on air power theory, *Air Power and Armies* (1936). In this book, he articulated the concept of air interdiction and argued for joint operations at a time when most air power theory concentrated on strategic bombardment.

Slessor was intimately involved in the RAF's pre-war planning and rearmament programs and played a significant role in building the alliance between the RAF and the U.S. Army Air Corps prior to America's entry into the war. Promoted to Air Vice-Marshal, Slessor commanded No. 5 Group in RAF Bomber command during the Command's early and frustrating years. He then returned to planning as Assistant Chief of Air Staff (Policy). Pyke argues that Slessor was instrumental in breaking the logjam that developed at the Casablanca Conference over future Allied strategy against the Axis.

Slessor went on to command RAF Coastal Command during the crucial and successful battle against the U-boats in 1943. He was then appointed Deputy Air Commander in Chief of Mediterranean Allied Air Forces, serving alongside U.S. Lt Gen Ira Eaker. Pyke describes how Slessor's diplomatic skills contributed to successfully building a multi-national air coalition on a scale never before attempted.

Pyke's final chapters cover Slessor's contributions to



the postwar RAF as Commandant of the Imperial Defence College. This position gave him time to think deeply about the role of air power in a postwar world of nuclear weapons. As Chief of the Air Staff from 1950 to 1952, Slessor was, in Pyke's view, the architect of Britain's policy of developing a nuclear deterrent. At a time when some British politicians favored leaving nuclear weapons to the United States, Slessor argued forcefully for Britain to develop its own nuclear capabilities and provided strong support to developing the family of long-range, nuclear bombers—the V-bomber force that went into service after his retirement.

This biography provides an excellent introduction to Slessor's career, with a comprehensive bibliography for further reading. Highly recommended.

*Edward Young, PhD, volunteer, Museum of Flight, Seattle WA*



**Black Snow: Curtis LeMay, the Firebombing of Tokyo, and the Road to the Atomic Bomb** (prepublication edition). by James M. Scott. New York: W. W. Norton and Company. 2022. Notes. Bibliography. Index. Photographs. Maps. Pp. 432. \$35.00. ISBN: 978-1-324-00299-4

James M. Scott is a former Nieman Fellow at Harvard. He is the author of *Rampage*, which was named one of the Best Books of 2018. His other works include *Target Tokyo*, a 2016 Pulitzer Prize finalist, *The War Below*, and *The Attack on the Liberty*, which won the Rear Admiral Samuel Eliot Morison Award.

The United States' strategic bombing campaign against Japan began in earnest in mid-1944 and intensified during the war's remaining months, ending with the atomic bombings of Hiroshima and Nagasaki in August 1945. This campaign was one of the main factors which influenced the Japanese surrender in mid-August 1945. Bases in the Mariana Islands supported an intensive air campaign against Japan. The Twentieth Air Force's XXI Bomber Command began arriving in the Marianas during October 1944. The command was led by Brigadier General Haywood S. Hansell, whose preferred campaign of precision bombing was unsuccessful, primarily due to adverse weather conditions over the Japanese Islands. In addition, poor maintenance practices reduced the number of aircraft which were available for operations. Major General Curtis LeMay replaced Hansell and changed tactics by improving aircraft availability and beginning firebombing attacks on Japan's main cities during early March 1945. He maximized the effectiveness of the firebombing attacks by ordering the B-29s to fly at 5,000 feet, at night.

Scott provides a description of the people involved and events leading up to the change from a precision-bombing strategy to low-altitude, nighttime incendiary bombing. He relates operational challenges faced by air crews, planning

obstacles, and the controversial moral problems that had to be surmounted to inflict such destructive area conflagration to the home-based industries and citizenry of Japan's large, medium, and rural cities. LeMay said, "Behind every combat mission flown by the Superforts lay an incredible amount of training, planning, sweat, sacrifice and just plain guts." The book provides many details on the number of aircraft involved, bombed cities and areas, casualties, and ordinance payloads involved.

The reader is also presented with what the Japanese people endured during the horrific campaign. Scott covers, in particular, the bombing of Tokyo and the raid of March 10, 1945, which the U.S. Strategic Bombing Survey calls "one of the greatest catastrophes in all history." A short chapter relates the dropping of the atomic bomb, *Little Boy*, on Hiroshima on August 6, 1945. Scott reflects the opinion that the atomic bomb served largely as a political weapon, altering Japan's domestic calculus. He feels that Russia's declaration of war was of equal importance by ending Japan's unrealistic hopes that the Soviets might broker a peace settlement obviating the U.S. insistence on unconditional surrender. General Hap Arnold told reporters that the bomb itself provided a way out for the emperor.

Scott delivers a well-researched narrative. He draws on personal interviews with American pilots and bombardiers and Japanese survivors, air force archives, and oral histories never before published in English. The notes he provides on each chapter will serve the researcher well. The book is a good read.

*Frank Willingham, National Air and Space Museum docent*



**Czechoslovak Arms Exports to the Middle East Volume 1: Origins, Israel and Jordan 1948-1989.** By Martin Smisek. Warwick UK: Helion & Company, 2021. Photographs. Illustrations. Maps. Pp. 70. \$29.95 paperback. ISBN: 978-1-91437719-8

This is the first of a multi-volume project and it leaves a great deal of room for subsequent volumes. Smisek provides a significant amount of information in a very dense 70 pages. When Smisek says "origins," it is unclear if he means origins of the Czech arms industry, the Middle East conflict, Czech arms export to the world, or just customers in the Middle East. He has compiled a significant amount of factual and anecdotal information to build a case for Czechoslovakia being the primary armorer of all combatants in the never-ending Middle East conflicts.

Further complicating the story is Czechoslovakia's changing political/economic structure. The Czech military-industrial complex produced high-quality weapons throughout the 20th century and sold them to anyone who could pay the price. The catalogue of products is huge:

small arms to armored vehicles, simple flight trainers to supersonic interceptors, and spare parts and ammunition as required. While the reason for the huge industrial capacity was to support the Czech armed forces, “surplus” capacity was used to create products sold around the world to earn hard currency. Although a member of the Soviet Bloc, Czechoslovakia sold anything to anyone who could pay.

In the Middle East, that meant the Czechs were in the envious economic position of selling to both sides. Egypt and Syria were two of its biggest post-World War II customers. Israel bought not only hardware, but also training and technical services. It sent significant numbers of personnel to Czechoslovakia for advanced training. In some cases, Israeli pilots went to Czechoslovakia for training and ferried aircraft back to Israel—and, in one case, conducted bombing missions on the way home.

Smisek never makes clear whether it is Czech or Soviet bureaucrats who really decided what to sell to whom. And it is never clear if the Soviets “skimmed” some of the profits or left all that hard currency in Prague. Given the Byzantine and inherently corrupt nature of the Soviet international banking and exchange system, it is hard to believe that Russian fingers were not in the till at some point in the process.

The book has copious notes and promises a complete bibliography in a future volume. It contains many photographs, several pages of color profile drawings, and numerous charts showing everything from “Known Exports to Country X” and types and amounts of weapons sold to customers within the 1948-1989 window.

This book was anything but a casual, recreational read. The text is extraordinarily dense, and the narrative does not flow smoothly. The book is in a large soft-cover format—great for illustrations and photographs but not for the text. I found more typographical errors than I would expect. While it is the first book on this specific topic, it is the thirty-ninth in Helion’s “Middle East @ War” series. For the reader or researcher with a niche interest in this specific subject, the copious notes may prove worthwhile, but I cannot recommend it to the casual reader.

*Gary Connor, docent, Smithsonian National Air and Space Museum’s Udvar Hazy Center*



**Test Pilot: An Extraordinary Career Testing Civil Aircraft.** By Chris Taylor. Barnsley UK: Pen and Sword Books. 2022. Appendices. Glossary. Photographs. Illustrations. Pp. 328. \$49.95. ISBN: 978-1-39908-534-2

Chris Taylor has flown a dizzying 400 different aircraft types! He is a licensed Category One test pilot and flight-test instructor for both aircraft and helicopters. He obtained his private pilot’s license at age 17 and began his

service flying career with the Royal Navy, where he flew Wasp and Lynx helicopters. As a test pilot, he flew numerous types of experimental and research aircraft. He was a test pilot for the United Kingdom’s Civil Aviation Authority and later formed his own company, where he continues to test fly and certify a variety of civilian aircraft.

After a quick introduction and brief paragraph extolling the virtues of flight-test engineers, Taylor starts with wing walking in the good-old Boeing Stearman. There are several chapters on learning to fly and flight-testing various autogiros. He describes testing in Poland of the PZL SW-4 helicopter which was one of his first “ugly” aircraft (later, in Arizona, they got it right). Other helicopters include the Sikorsky S-92 and S-61, Whirlwind, Wasp, Huey, OH-6, Brantley B-2B, and Hiller UH-12E. Taylor also includes many propeller and jet aircraft that include the Spitfire, Harvard, Sea Fury, Yale (remember that one?), Folland Gnat, Vampire T.11, Fieseler Storch, Edgley Optica, and the Tiger Moth. To ensure that the reader does not end with an overly strong impression of his prowess as a pilot, Taylor ends with a collection of “cock-ups”—issues and embarrassments that beset him during his career.

Taylor has compiled a collection of anecdotes and humorous stories about his flying career. One wing commander who read Taylor’s book says that, “Chris writes like he’s telling you a tale after a couple of beers! His stories are hilarious and scary in equal measure!” Taylor himself admits that the book is an odd one to read. He openly confesses that he wrote it for his children and grandchildren to fill in the blanks about his professional career. He worries that he dumbed it down for some, while providing too much technical detail for others. As a pilot and flight test engineer myself, I would have liked to see more of the latter. His aircraft are all listed in Appendix III (I did not count them!).

The volume is somewhat repetitious. I would have liked to have an index for reference. However, it is a fun book to read. For the uninitiated, it provides a good overview of flight-testing challenges.

*Frank Willingham, National Air and Space Museum docent*



**Naval Aviation in the Korean War.** By Warren Thompson. Barnsley UK: Pen & Sword, 2022. Tables. Photographs. Appendices. Pp. 175. \$28.95 paperback. ISBN: 978-1-39908-515-1

With more than 30 books and several hundred magazine articles to his credit, Thompson is best known for his research into aerial combat in the Korean War. In this book (a reprint from 2012), he examines the numerous U.S. Navy aircraft-carrier cruises supporting the United Nations between June 1950 and July 1953. With a couple of



exceptions, land-based aviation is omitted.

Proceeding in chronological order, Thompson looks at the impact of carrier-based airpower as the land war unfolded. The first chapter concerns the UN's initial efforts to prevent the North Korean army from pushing all South Korean and U.S. forces off the peninsula.

In the second chapter, naval aviation played a critical role in supporting the landing at Inchon (west of Seoul) in September. With significant forces in their rear, the North Koreans were forced to retreat northward to the Yalu River, which separated Korea from China.

The Chinese intervened in October and November 1950. Their overwhelming force in severe winter weather prompted the Navy to use all its available assets to slow the surge and enable UN forces to regroup farther south.

By the spring and summer of 1951, the front line had stabilized. In the fourth chapter, Thompson discusses how Navy pilots focused on close air support and interdiction of Communist supply lines in an effort to stymie offensive threats and support UN offensives.

The fifth chapter is devoted to a discussion of the primary carrier-based aircraft employed by the Navy: the Douglas AD Skyraider, Grumman F9F Panther, McDonnell F2H Banshee, and Vought F4U Corsair.

While providing no notes, Thompson frequently refers to records from various aircraft carrier deployments, providing detailed information. Rather than list every mission, he selects those of particular interest. At the same time, he blends in interviews with pilots.

Because the carriers usually operated in the Sea of Japan, their aircraft focused on hitting targets in the eastern part of the peninsula, a considerable distance from where the Russian-built MiG-15 fighters were based. Consequently, Navy aircraft seldom engaged in air-to-air combat. However, in one instance, they did encounter Russian-piloted MiGs and achieved a decisive victory.

High-quality photographs are one of the strengths of this book. Both black-and-white and color shots are included. The high-gloss paper is well suited for this presentation. But this is hardly a picture book. The richly detailed narrative makes it an easy and very informative read.

Unfortunately, readers unfamiliar with the location of towns and cities, lines of communication, and geographical features will find the absence of maps a serious shortcoming. Nevertheless, this book is highly recommended for anyone interested in naval aviation, the Korean War, or both.

*Steven D. Ellis, Lt Col, USAFR (Ret), docent, Museum of Flight, Seattle*



**When the Shooting Stopped: August 1945.** By Barrett Tillman. Oxford UK: Osprey Publishing, 2022. Photographs. Notes. Bibliography. Index. Pp. 304. \$35.00. ISBN: 978-1-4728-4898-7

The first thought that struck me when I finished *When the Shooting Stopped* was that the shooting did not really stop at all. The shooting associated with the Pacific Theater in World War II diminished to a trickle, but the last Japanese combatant did not surrender until thirty years later. The civil war on the Chinese mainland intensified and armed conflicts in Southeast Asia and the former British and Dutch colonies erupted periodically. But the war against the Japanese Empire did end to the point where the Allies could begin significant disarmament, demobilization, and reconstruction programs. Tillman weaves a chronology of August 1945. He includes people and events large and small to give the reader a complete picture of that pivotal month in history.

Tillman is a skilled storyteller. His work is typically a comfortable read. His writing is clear and uncomplicated—almost simplistic. While he seldom introduces “new” or controversial information, his research is impeccable, and his conclusions are well-founded. And he scatters numerous “Easter eggs” throughout which both entertain and inform. These nuggets also are valuable trivia fodder. For example, when Japanese and American envoys met for the first time to discuss the proposed surrender mechanisms, what language did they use to communicate? The answer is German. The American spokesman was raised in Germany, while his Japanese counterpart had served as an attaché in Berlin.

Of course, many of the anecdotes are well known to most armchair historians. While it is always interesting to hear them told by a skilled storyteller, the lack of new information or observations left me feeling a bit let down.

The book contains several pages of photographs of personages mentioned throughout the book, but there were no maps. I found that disappointing. For example, Tillman's discussion of the Russian-Japanese conflict in the Battles of Khalkin Gol was one of the few times he dove into topics that might not be familiar to most readers. Occurring in 1939, it was the largest battle involving armored vehicles up to that time, and Zhukov's tactics presaged both the Wehrmacht's blitzkrieg tactics and the tactics used by Russia when they attacked Japanese forces in Manchuria in August 1945. A few maps or drawings would have been extremely helpful to readers unfamiliar with the subject.

Tillman is a very competent and comfortable writer. His prose is simple and direct. He makes no pretenses about his storytelling. He does not challenge readers so much as he invites them in so that he can tell them a story. It may be a story the reader has heard before; but, in the hands of a skillful storyteller, an old story can be brought to life in new and interesting ways.

*Gary Connor, docent, Smithsonian National Air and Space Museum's Udvar Hazy Center*



---

**The First Jet Pilot: The Story of German Test Pilot Erich Warsitz.** By Lutz Warsitz. Barnsley UK: Pen and Sword. 2021 (reprint of 2008). Photographs. Maps. Illustrations. Index. Pp. 176. \$26.95 paperback. ISBN: 978-1-39908327-0

Lutz Warsitz is the son of aviator Captain Erich Warsitz. Written primarily in the first person, the book feels like an autobiography. Warsitz had two lengthy interviews with his father, repackaged his father's memories, and augmented them with snippets of quotes and conversations between his father and other German aviation notables. However, with a layer of interpretation added by the translator, the narrative became a bit muddled.

Erich Warsitz was the first pilot of a turbojet aircraft. In August 1939 he flew a Heinkel He 178 powered by a jet engine designed by von Ohain. What receives less attention is that three months prior, he flew a rocket-powered He 176 using a propulsion system designed in large part by Werner von Braun. While it took years to bring these nascent technologies to sufficient maturity to support weapon systems, two flights of such watershed developments with the same hands on the controls was extraordinary. Warsitz also served as a key technical advisor during the simultaneous design and development programs.

For those aviation historians more interested in the notorious, Warsitz rubbed elbows with such aviation notables as Heinkel and von Ohain along with Hitler, Göring, and Udet. His memories of these people are interesting. Forty-plus years later he remembered Hitler's "firm handshake." He remembered Göring directing Udet to pay Warsitz 20,000 reichsmarks (Rm) from the "special fund." Later Göring bumped the raise to 50,000 Rm for each first flight with bonuses for certain technical achievements. During 1937-39, retroactive pay and bonuses earned Warsitz 600,000 Rms annually! A top aviation engineer without Göring's sponsorship would have earned about 10,000 Rms annually. Göring left it to Warsitz to tell Heinkel of his test pilot's windfall. Historians who delve into German aircraft and engine designs may run across Heinkel engineer Robert Lusser. The book indicates Warsitz and Lusser were not the closest of friends, and Warsitz took pleasure in recounting Lusser's professional misfortunes.

Of course, events would conspire to ensure Warsitz collected none of his bounty. He served as a civilian technical advisor to the Luftwaffe until capitulation. Eventually he fell into the hands of the Russians, where he was employed as a technical advisor. Eventual repatriation returned him to East Germany, but his postwar life lacked the drama and adrenalin of his prewar aviation exploits.

*The First Jet Pilot* is an interesting read. It took me a while to sort out whether a given phrase was the thought of the author or his father. I felt that the son sanitized a lot of his father's thoughts and memories. There were few personal memories: Was the cockpit hot/cold, noisy/quiet? Were the controls responsive/heavy? Importantly in early

jets, was the engine response to throttle movement fast/slow? While Warsitz knew the fuel for the rocket engine was highly corrosive and toxic, there is no mention of fear. Third party quotes supporting Warsitz's memories are helpful. But the narrative is clunky; it is not a smooth read. On the positive side, the photographs included are helpful.

*Gary Connor, docent, Smithsonian National Air and Space Museum's Udvar Hazy Center*



**Astonishing Stories Pilots Tell Pilots: Marines, Navy, Air Force, CIA, Airlines, Civilian.** By Robert N. Pripps. North Branch MN: Specialty Press, 2022. Tables. Illustrations. Pp. 149. \$19.95. ISBN: 978-1-55007-280-9.

Pripps, an experienced civilian pilot, has written more than 30 books about farm tractors. His passion for flying prompted him to share numerous aviation stories that he picked up over the years. Some have been published previously, and he carefully makes that distinction. However, most appear in print for the first time.

About two-thirds of the stories involve military or Central Intelligence Agency pilots with the balance devoted to airline and civilian operations. Each story begins with a silhouette depiction of the aircraft featured in the narrative. Also included is a table describing the aircraft. Included are the nickname, crew, length, wingspan, empty weight, maximum weight, engine, maximum speed, range, and ceiling.

Most of the stories concerning military aircraft deal with jets operational from the 1950s and 1960s. However, the oldest included is the Douglas A-20, a World War II, twin-engine, light bomber. Other World War II aircraft mentioned are the Curtiss C-46 and the Focke-Wulf Fw 190. The newest are the Boeing F/A-18 and Lockheed Martin F-16. Two helicopter pilots (Boeing CH-46 and Bell UH-1) tell their stories as well.

With a couple of exceptions, most stories run 1,500 words or less. Some deal with combat operations in Korea or Vietnam, while others involve test flights or unusual circumstances.

Stories about airliners are limited to those involving Concorde, the Boeing 777, and the Lockheed L-188 Electra. Pripps also chose to include a few brief anecdotes regarding conversations between pilots and air traffic controllers.

The civilian section features tales concerning nine different aircraft. In most instances, the stories are very brief. While a few are humorous, the stories generally reflect extreme situations where the pilot fortunately made the best decision possible and avoided catastrophic results. This book is best suited for a general audience. From a personal perspective, I gained insight into what it was like to fly some of the types of aircraft on display at the Museum of Flight in Seattle—the kinds of tales that bring life to the otherwise static artifacts.

*Steven D. Ellis, Lt Col, USAFR (Ret.)*